



DLC Carbide End Mills for Non-ferrous Materials

AE-N SERIES

AE-TS-N · AE-TL-N · AE-VTS-N · AE-VTFE-N · AE-LNBD-N · PXAL

Volume 3





AE-TS-N Short

- 1,5xD cutting length (Neck length 3 x D)
- Ø 3 ~ Ø 25
- DLC-Super Hard Coating

Features	PAGE	8
Dimensions square & CR type	PAGE	12
Dimensions SP	PAGE	13
(sharp corner edge type)		
Cutting conditions	PAGE	16-17



AE-TL-N Long

- 3xD & 5xD cutting length
- Ø 3 ~ Ø 25
- DLC-Super Hard Coating

Features	PAGE	8
Dimensions square	PAGE	14
Dimensions SP	PAGE	15
(sharp corner edge type)		
Cutting conditions	PAGE	18-19



AE-VTS-N Short (High performance type)

- 1,5xD cutting length (Neck length 3xD)
- Ø 3 ~ Ø 12
- DLC-IGUSS Coating

Features	PAGE	20
Dimensions square & CR type	PAGE	23
Dimensions SP	PAGE	24
(sharp corner edge type)		
Cutting conditions	PAGE	25-26



AE-VTFE-N (Deep side milling)

- 2,5xD cutting length (reduced shank)
- Ø 6 ~ Ø 22
- DLC-IGUSS Coating

Features	PAGE	28
Dimensions	PAGE	32
Cutting conditions	PAGE	33



AE-LNBD-N

- 2 flute long neck ball type
- R0,05 - R3
- DLC-IGUSS Coating

Features	PAGE	34
Dimensions	PAGE	39
Cutting conditions	PAGE	41











PXAL (Exchangeable head end mill)

- 1xD cutting length
- Ø 10 ~ Ø 25
- DLC-IGUSS Coating

Features	PAGE	42
Dimensions heads	PAGE	45
Dimensions PXMZ holders	PAGE	46-47
Cutting conditions	PAGE	48-49
PXMC collet & holder	PAGE	50~

APPLICATION

Application				Slot Milling	Trochoidal Milling	Side Milling	Deep Side Milling	Plunging	Helical Milling	Contour Milling	Ramping
											
Standard	AE-TS-N Short	1.5 × D cutting length	Square Sharp Corner Edge Radius	◎	☆	☆	○	◎	◎	◎	◎
	AE-TL-N Long	3 × D cutting length	Square Sharp Corner Edge	○	☆	◎	◎	○	◎	○	○
		5 × D cutting length	Square Sharp Corner Edge	△	☆	○	◎	△	○	△	△
High Performance	AE-VTS-N Short	1.5 × D cutting length	Square Sharp Corner Edge Radius	☆	☆	☆	☆	☆	☆	☆	☆
	AE-VTFE-N Deep side milling	2.5 × D cutting length	Square Radius	△	◎	○	☆	△	○	△	△
	PXAL Exchangeable Head	1 × D cutting length	Square Radius	☆	☆	☆	☆	☆	☆	☆	☆

△ → ○ → ◎ → ☆
(Fair) (Best)

DLC coated end mills for deep side milling in non-ferrous metals

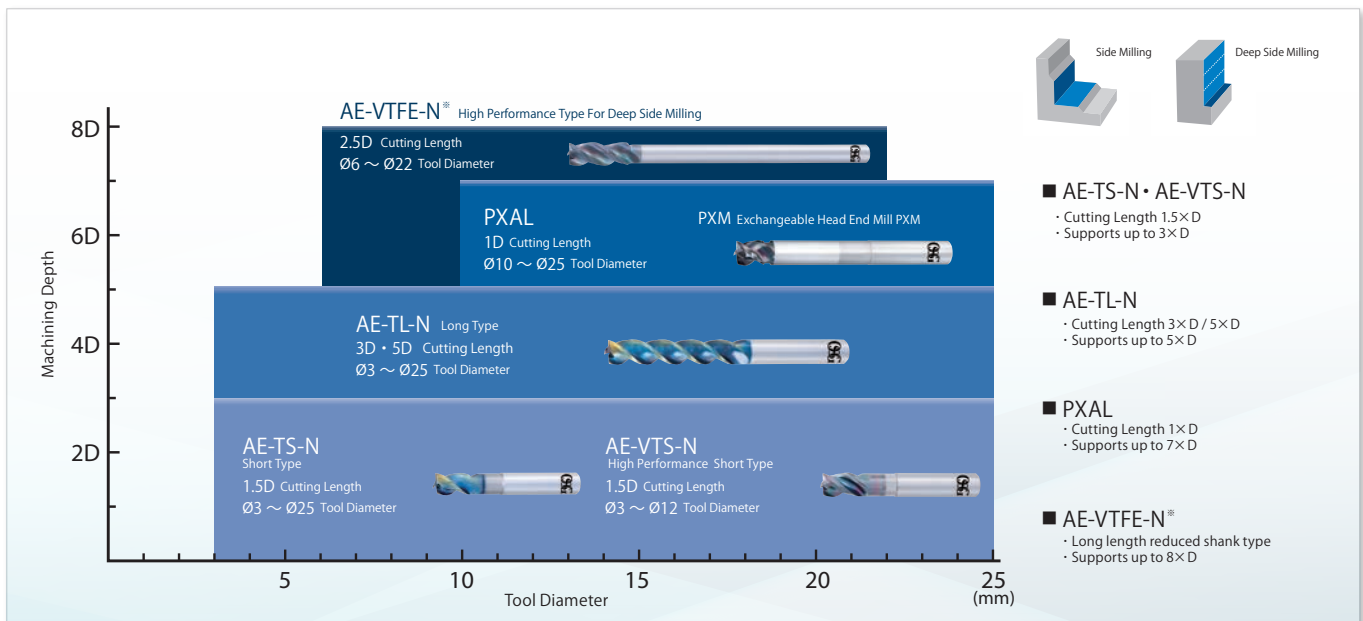

*Please use the Ø22 AE-VTFE-N at L/D = 7 or less.



FEATURES OF DLC COATING

DLC coating revolutionizes the processing of non-ferrous materials!

OSG's DLC coating gives a shiny surface! This shiny and smooth surface optimizes end mill performance particularly in non-ferrous materials such as aluminum alloys, which require welding resistance and lubricity.

Two types of DLC coatings to accommodate specific application needs

DLC-IGUSS

- Thick coating type for long tool life
- Thick coating type suppresses wear on the cutting edge to enable high durability and long tool life.
- Applicable tools : AE-VTS-N • AE-VTFE-N • PXAL

DLC-SUPER HARD

- Thin coating type with emphasis on sharpness
- High adhesion to the base material to enable sharp cutting performance and high welding resistance.
- Applicable tools : AE-TS-N • AE-TL-N • AE-VTFE-N

Name of Coating	Coating Color	Coating Type	(GPa) Hardness	Oxidation Temperature (C°)	Coefficient of Friction	(µm) Coating Thickness	Coating Temperature (C°)	Surface roughness	Wear Resistance	Welding Resistance	Toughness
DLC-IGUSS	Interference Color	DLC(SP ³ Rich)	60	550	0.10	0.8	400	☆	◎	☆	○
DLC-SUPER HARD	Interference Color	DLC(SP ³ Rich)	60	550	0.10	0.2	400	☆	◎	☆	○

(Good) ○ → ◎ → ☆ (Best)

Abrasion resistance and welding resistance

OSG's DLC coating has high wear resistance and anti-adhesion properties, which enable stable tool life in non-ferrous material applications with high tendency to weld.



Wear resistance

Milling in A5052

Tool	Carbide Square End Mill 3 Flutes
Work Material	A5052
Cutting Speed	200m/min (6.370 min ⁻¹)
Feed	0,08mm/t (1.530mm/min)
Depth of Cut	ap = 5mm ae = 8mm
Coolant	AirBlow
Machine	Vertical Machining Center
Milling Length	50m

Welding resistance

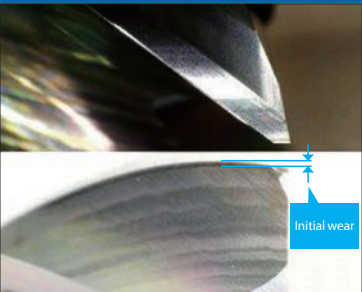
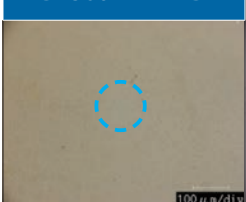
Surface condition after pin-on-disc test

DLC-IGUSS	DLC-SUPER HARD	Non coat (Carbide)
		
Test Material		A7075
Test Environment		Open atmosphere

CUTTING DATA ON ALUMINUM PART PROCESSING

Suitable for a wide range of applications

Coolant	MQL	Holder	Shrink Fit	Machine	5 axis Machining center
Max. RPM	25.000 min ⁻¹	Work Material	A5052	Main Spindle	HSK63



Process	Milling Part	Milling Method	Milling Process	Tool
①	Top	Face Milling	Roughing	PXAL 250C25-03R100
②	Overall	Contour Milling	Roughing	PXAL 200C20-03R100
③	Top	Face Milling	Finishing	AE-TS- N Ø12x36
④	Boss, Hole Side	Side Milling	Finishing	
⑤	Hole Top	Face Milling	Finishing	AE-VTS- N Ø12x36
⑥	Counterbore Wall	Side Milling	Finishing	
⑦	Groove	Pocket Milling	Roughing	AE-VTS- N Ø10x30
			Finishing	
⑧	Bottom	Pocket Milling	Roughing	AE-VTS- N Ø10x30
			Finishing	
⑨	Slot	Slot Milling 5-axis	Finishing	AE-TS- N Ø10x30
⑩	Outer circumference, lower counterbore	Side Milling	Finishing	AE-TL- N Ø8x40

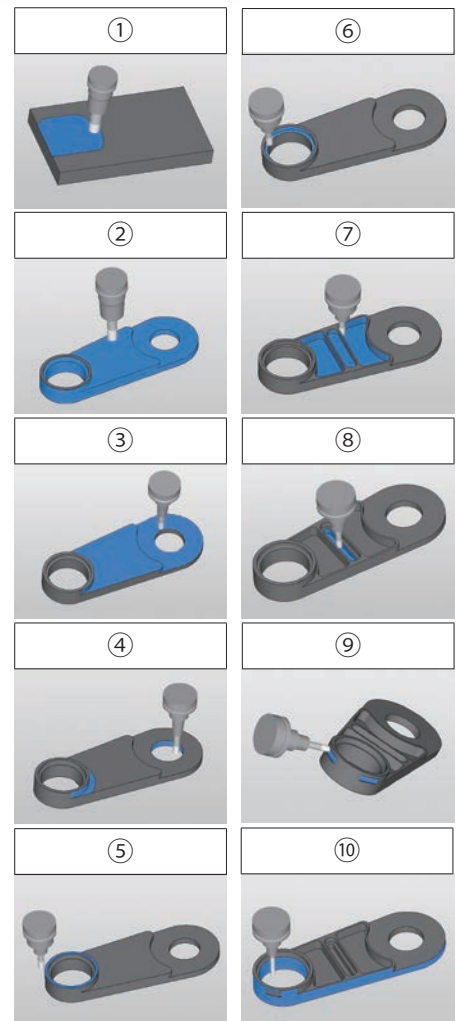

Milling | Solid carbide



CUTTING DATA ON ALUMINUM PART PROCESSING

High efficiency and high quality deep side milling and pocket milling

Part Name	Vacuum Chamber
Work Material	A5056
Machine	5 axis Machining center
Main Spindle	HSK-A63
Coolant	MQL

However, water-soluble coolant is used for threading and drilling

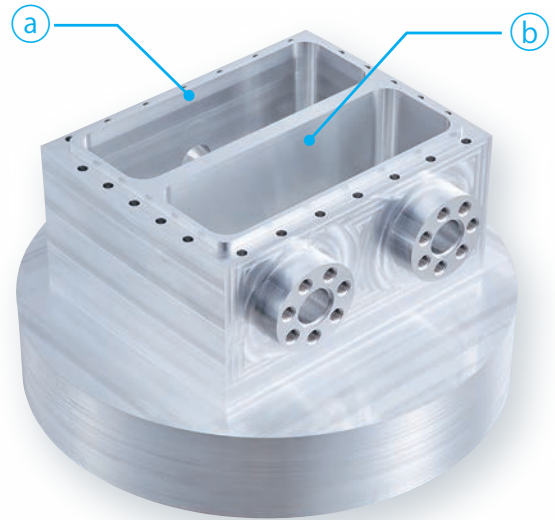

Process	Processing Location	Milling Process	Tool
①	Top and Side	Roughing·Finishing	PFAL04R100M25.4-8 Ø100
②	Side Convex Part	Roughing·Finishing	AE-VTFE-N Ø12 (L/D=5.5 66mm)
③	Side	Roughing·Finishing	AE-VTFE-N Ø12 (L/D=8 96mm)
④	a、b Pocket	Roughing	AE-TS-N Ø20×60
		Bottom Finishing	
⑤	a Pocket	Semi-finishing·Finishing	AE-VTFE-N Ø12 (L/D=5.5 66mm)
⑥	b Pocket	Semi-finishing·Finishing	AE-TL-N Ø12×60
⑦	Side Convex Part	Helical Milling	AE-VTFE-N Ø12 (L/D=5.5 66mm)
		Counterboring	
		Chamfering	PLDS11R002SS16-90 Ø14.4×90°
		M8×1,25 Threading	AT-2 R-SPEC M8×1.25 6.2×16 P1.25 INT
⑧	Seal Surface	Roughing·Finishing	AE-VTS-N Ø10×30
		Drilling	NF-GDN Ø5

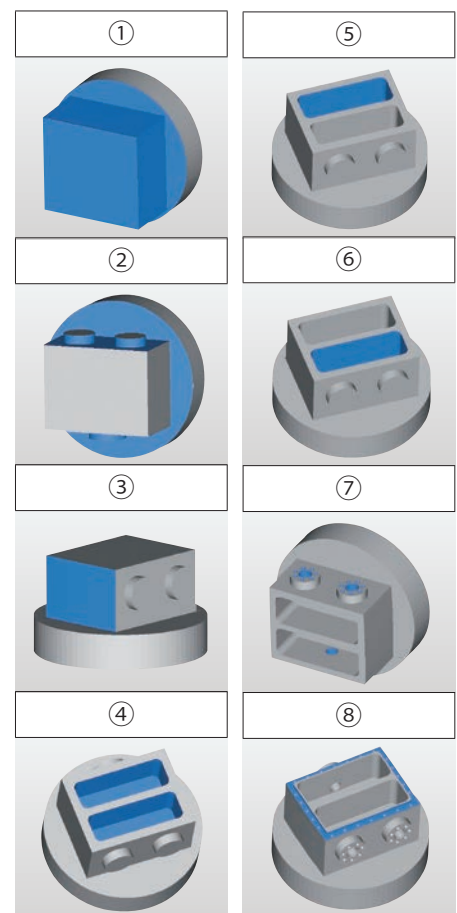

Milling | Solid carbide



CUTTING DATA ON ALUMINUM PART PROCESSING

Optimum tooling for highly efficient machining

High-efficiency machining in which 4 processes are completed in a total of 8 minutes and 30 seconds

Part Name	Inverter Case
Work Material	AC4C
Machine	SPEEDIO series
Main Spindle	BT30
Coolant	Water-Soluble

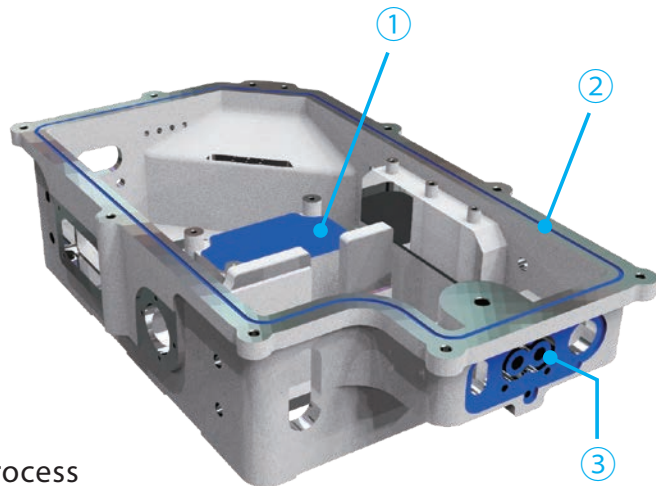

Cooperation : BROTHER INDUSTRIES, LTD.

SPEEDIO

Introduction of a part of the machining process

Processing Location	Tool	Process	Depth of Cut		Milling Condition	
			a _p (mm)	a _e (mm)	Cutting Speed (m/min)	Feed (mm/min)
①	Head: PXAL200C20-03R000 Ø20 Holder: PXMZ-C200SS20-S120	Face Milling	4	18	500 (8.000min ⁻¹)	4.000 (0.167mm/t)
②	AE-TS-N Ø3×9	Slot Milling	1	3	150 (16.000min ⁻¹)	2.000 (0.042mm/t)
③	AE-VTS-N Ø10×30	Slot Milling	1,5	10	410 (13.000min ⁻¹)	3.820 (0.098mm/t)

List of tools used

Main Machining	Tool
Mating Surface	PFAL04R063M22-8 Ø63
Face Milling	Head: PXAL 200C20-03R000 Ø20 Holder: PXMZ-C200SS20-S120
Contour Milling	Head: PXAL 200C20-03R000 Ø20 Holder: PXMZ-C200SS20-S120
	AE-VTS-N Ø10×30
	AE-VML Ø12×48-N
Slot Milling	AE-TS-N Ø3×9
	AE-VTS-N Ø10×30

Main Machining	Tool
Drilling	ADO-SUS-3D Ø2.8
	ADO-SUS-3D Ø3.5
	ADO-SUS-3D Ø4.2
	ADO-SUS-3D Ø7.9
Flat Surface Drilling	P2D3000BT30M09 Ø30 Special
	ADF-2D Ø13
Chamfering	AD-LDS Ø8×90°

Main Machining	Tool
Threading	A-SFT M4×0.5
	A-SFT M5×0.8
	S-XPFP M3×0.5
	AT-2 R-SPEC M8×1.25 6.2×16 P1.25-INT
Hole Finishing	CRM Ø8

Milling | Solid carbide

Enables dramatic reduction in machining time!

High-efficiency thread mill with end-cutting edge for non-ferrous metals

AT-2 R-SPEC

A
The A Brand

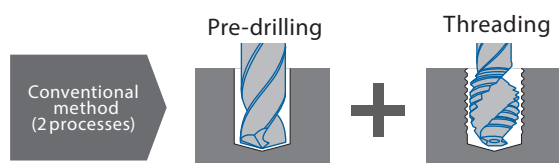

Useful for preventing shifting of cutting position in cast hole



KEY FEATURES: AE-TS-N • AE-TL-N

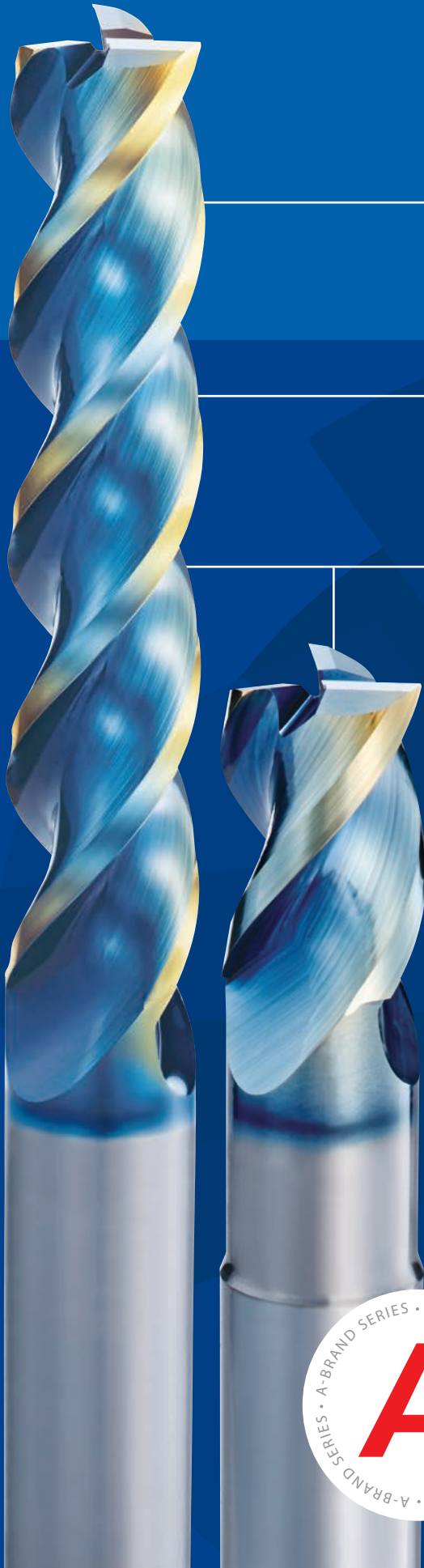

- 1** Cutting edge specification that achieves both rigidity and sharpness. Achieves high durability and good surface finish
- 2** New flute form. Facilitates excellent chip evacuation.
- 3** DLC-SUPER HARD Coating

Due to the smoothness of the coating surface, it is extremely effective for non-ferrous materials such as aluminum alloys that require welding resistance and lubricity. Furthermore, its excellent sharpness and ability to suppress burrs enable superior surface finish.



STANDARD SPECIFICATION SUITABLE FOR NON-FERROUS MATERIAL PROCESSING

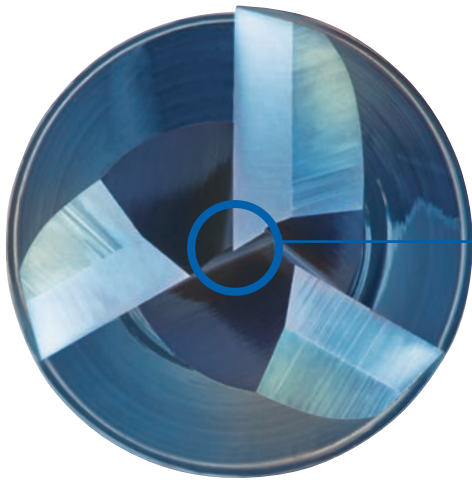

Large core design

High rigidity prevents chattering

Center cutting edge

Can be used for plunging

Balancing rigidity and chip evacuation capability

Rigidity is enhanced by increasing the core thickness, which enables the suppression of chattering. By adopting an optimal flute form, high rigidity can be maintained while ensuring trouble-free chip evacuation.

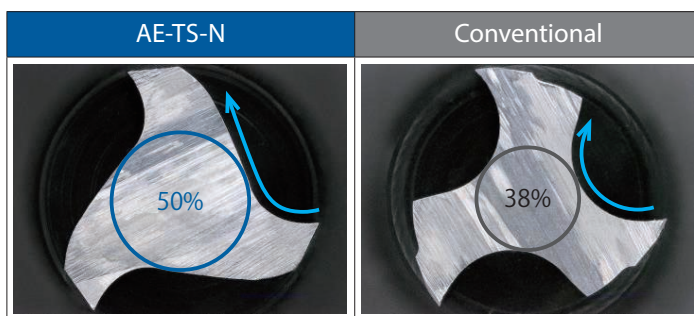

Arrow: indicates chip discharge direction

CUTTING DATA

High Quality

High welding resistance

By adopting the DLC coating, high welding resistance is achieved even with air blow.

Tool	AE-TS-N φ10×30	Non-coated Competitor φ10 3 Flutes
Work Material	A7075	
Milling Method	Slot Milling	
Cutting Speed	300m/min (9,550min ⁻¹)	
Feed	1,432mm/min(0.05mm/t)	
Depth of Cut	ap =10mm	
Coolant	AirBlow	
Machine	Vertical Machining Center	

Cutting edge condition after milling 11 m

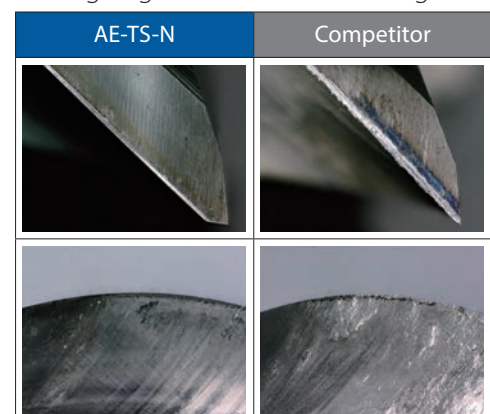

CUTTING DATA

High precision, Good machined surface quality

Effects by the combination of DLC coating and unique cutting edge specification for non-ferrous metal machining

Achieves good machined surface quality.

Tool	AE-TS-N Ø20 Square	Conventional
Work Material	A7075	
Milling Method	Side Step Milling	
Cutting Speed	300m/min (4.750 min ⁻¹)	
Feed	700mm/min (0,05 mm/t)*	
Depth of Cut	ap = 20mm X 2 Times ae = 6mm	
Coolant	Water Soluble	
Machine	Horizontal Machining Center (BT50)	

*Machined at a reduced feed rate for the cutting trial.

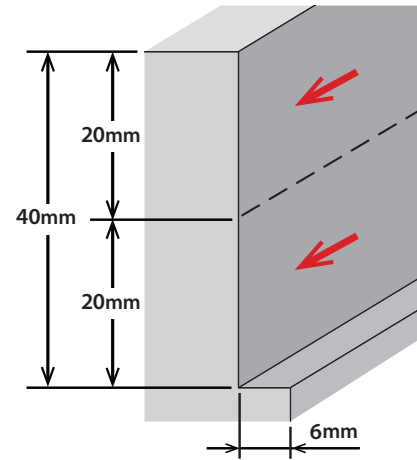

Good machined surface

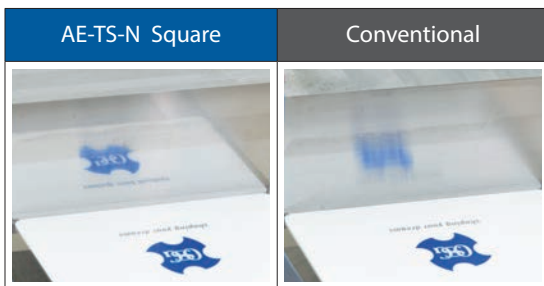

Side roughness at the initial stage of machining

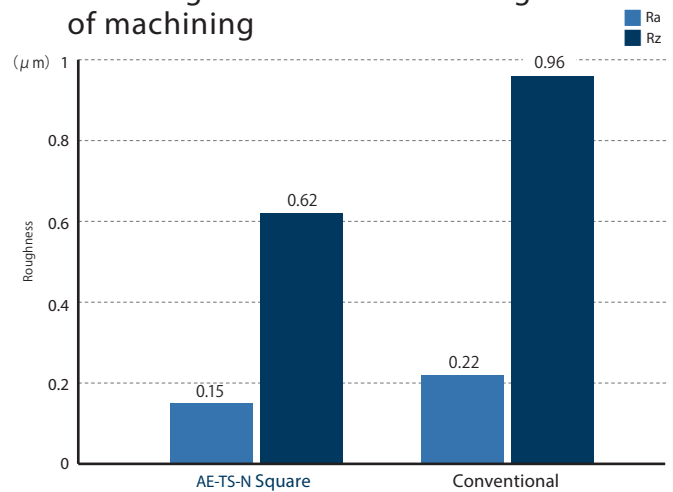

Effects of the radius type

The radius type is effective in improving the machined surface quality of the bottom surface.

Tool	AE-TS-N Ø6 x 18 x R0,5 Radius	AE-TS-N Ø6 x 18 Square
Work Material	A7075	
Milling Method	Slot Milling	
Cutting Speed	Vc=350m/min (18.568 min ⁻¹)	
Feed	Vf=2.785mm/min (0,05 mm/t)	
Depth of Cut	ap = 6mm (1D)	
Coolant	Water Soluble	
Machine	Vertical Machining Center (BT40)	

Bottom roughness at the initial stage of machining

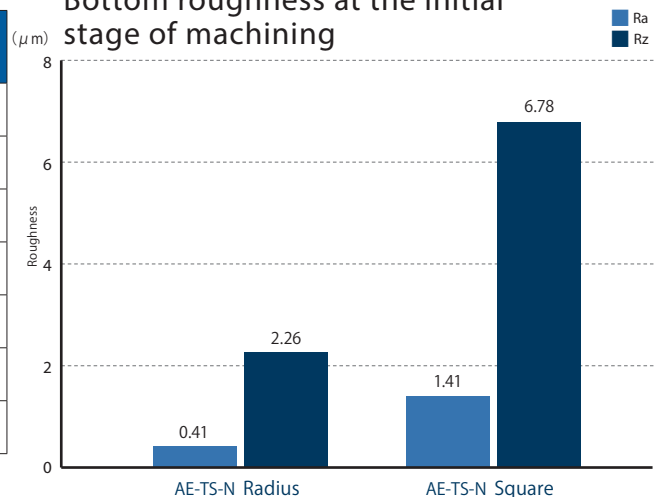

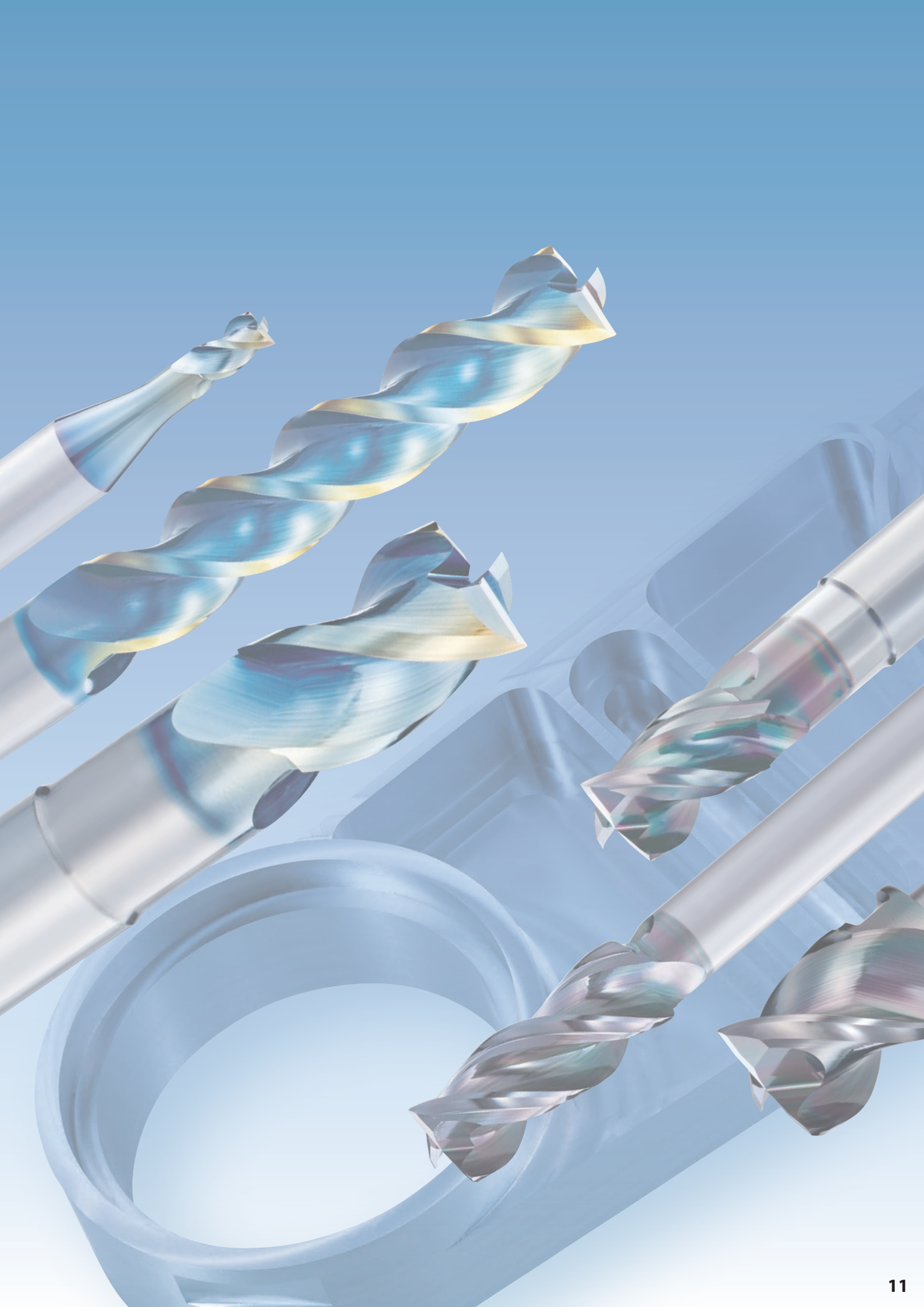

AE-TS-N NEW SIZES

Milling | Solid carbide



Type 1

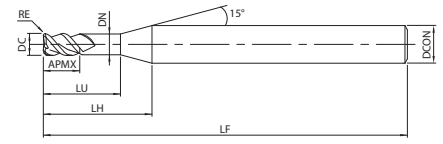

Type 2

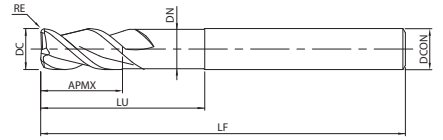

- First choice in quality and performance
- Carbide end mill with DLC coating
- For Non-Ferrous Materials
- 3 flutes, short length of cut



Milling | Solid carbide



EDP	ZEFP	DC	RE	LU	LF	APMX	LH	DCON	DN	Type	Price
8557330	3	3	-	9	55	4,5	14,8	6	2,85	1	
8557370	3	3	0,2	9	55	4,5	14,8	6	2,85	1	
8557371	3	3	0,5	9	55	4,5	14,8	6	2,85	1	
8557331	3	4	-	12	55	6	15,9	6	3,8	1	
8557372	3	4	0,2	12	55	6	15,9	6	3,8	1	
8557373	3	4	0,5	12	55	6	15,9	6	3,8	1	
8557374	3	4	1	12	55	6	15,9	6	3,8	1	
8557332	3	5	-	15	55	7,5	16,8	6	4,8	1	
8557375	3	5	0,2	15	55	7,5	16,8	6	4,8	1	
8557376	3	5	0,5	15	55	7,5	16,8	6	4,8	1	
8557377	3	5	1	15	55	7,5	16,8	6	4,8	1	
8557333	3	6	-	18	60	9	-	6	5,8	2	
8557378	3	6	0,3	18	60	9	-	6	5,8	2	
8557379	3	6	0,5	18	60	9	-	6	5,8	2	
8557380	3	6	1	18	60	9	-	6	5,8	2	
8557334	3	8	-	24	70	12	-	8	7,7	2	
8557381	3	8	0,3	24	70	12	-	8	7,7	2	
8557382	3	8	0,5	24	70	12	-	8	7,7	2	
8557383	3	8	1	24	70	12	-	8	7,7	2	
8557384	3	8	1,5	24	70	12	-	8	7,7	2	
8557385	3	8	2	24	70	12	-	8	7,7	2	
8557335	3	10	-	30	75	15	-	10	9,7	2	
8557386	3	10	0,3	30	75	15	-	10	9,7	2	
8557387	3	10	0,5	30	75	15	-	10	9,7	2	
8557388	3	10	1	30	75	15	-	10	9,7	2	
8557389	3	10	1,5	30	75	15	-	10	9,7	2	
8557390	3	10	2	30	75	15	-	10	9,7	2	
8557391	3	10	3	30	75	15	-	10	9,7	2	
8557336	3	12	-	36	80	18	-	12	11,7	2	
8557392	3	12	0,3	36	80	18	-	12	11,7	2	
8557393	3	12	0,5	36	80	18	-	12	11,7	2	
8557394	3	12	1	36	80	18	-	12	11,7	2	
8557395	3	12	1,5	36	80	18	-	12	11,7	2	
8557396	3	12	2	36	80	18	-	12	11,7	2	
8557397	3	12	3	36	80	18	-	12	11,7	2	
NEW 8557337	3	16	-	48	110	24	-	16	15,7	2	
NEW 8557338	3	20	-	60	120	30	-	20	19,7	2	
NEW 8557339	3	25	-	75	140	37,5	-	25	24,7	2	

AE-TL-N NEW SIZES

Milling | Solid carbide



Type 1

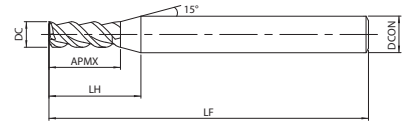

Type 2

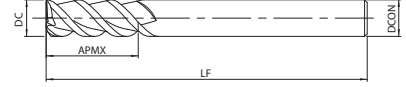

- First choice in quality and performance
- Carbide end mill with DLC coating
- For Non-Ferrous Materials
- 3 flutes, long length of cut



A
CARBIDE
DLC
0~0.02
41°
SHRINK FIT



EDP	ZEFP	DC	LF	APMX	LH	DCON	ULDR	Type	Price
8557340	3	3	55	9	16,6	6	3	1	
8557341	3	4	55	12	17,7	6	3	1	
8557342	3	5	55	15	18,9	6	3	1	
8557343	3	6	60	18		6	3	2	
8557344	3	8	70	24		8	3	2	
8557345	3	10	75	30		10	3	2	
8557346	3	12	80	36		12	3	2	
NEW 8557347	3	16	120	48		16	3	2	
NEW 8557348	3	20	135	60		20	3	2	
NEW 8557349	3	25	155	75		25	3	2	
8557350	3	3	55	15	22,6	6	5	1	
8557351	3	4	60	20	25,7	6	5	1	
8557352	3	5	65	25	28,9	6	5	1	
8557353	3	6	75	30		6	5	2	
8557354	3	8	90	40		8	5	2	
8557355	3	10	100	50		10	5	2	
8557356	3	12	110	60		12	5	2	
NEW 8557357	3	16	150	80		16	5	2	
NEW 8557358	3	20	175	100		20	5	2	
NEW 8557359	3	25	205	125		25	5	2	

Milling | Solid carbide



AE-TL-N SP NEW

Milling | Solid carbide



Type 1

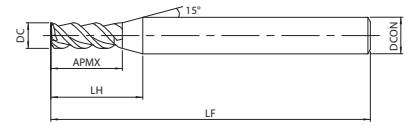

Type 2

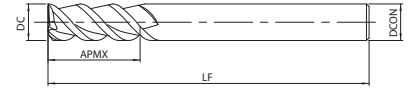

- First choice in quality and performance
- Carbide end mill with DLC coating
- For Non-Ferrous Materials
- 3 flutes, long length of cut
- Sharp corner for milling straight corner



A
CARBIDE
DLC
0~0.02
41°
SHRINK FIT
RA



EDP	ZEFP	DC	LF	APMX	LH	DCON	ULDR	Type	Price
8557440	3	3	55	9	16,6	6	3	1	
8557441	3	4	55	12	17,7	6	3	1	
8557442	3	5	55	15	18,9	6	3	1	
8557443	3	6	60	18	-	6	3	2	
8557444	3	8	70	24	-	8	3	2	
8557445	3	10	75	30	-	10	3	2	
8557446	3	12	80	36	-	12	3	2	
8557450	3	3	55	15	22,6	6	5	1	
8557451	3	4	60	20	25,7	6	5	1	
8557452	3	5	65	25	28,9	6	5	1	
8557453	3	6	75	30	-	6	5	2	
8557454	3	8	90	40	-	8	5	2	
8557455	3	10	100	50	-	10	5	2	
8557456	3	12	110	60	-	12	5	2	

Milling | Solid carbide

Sharp corner edge type for milling straight corners

The sharp corner edge type is designed without a gash land cutting edge specification, enabling it to mill straight corners.

Effective corner milling with no uncut residue left behind.

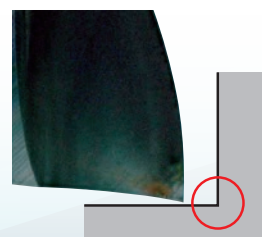

Sharp Corner Edge (SP)

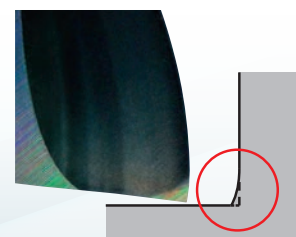

Square Type

CUTTING CONDITIONS

Milling | Endmills | Cutting conditions

AE-TS-N Applies to square/sharp corner edge/radius type

Slot Milling

Vc (m/min)	Aluminum Alloy Expanding Material • Magnesium Alloy A5052 • A7075 • AZ91 • AZ80A		Aluminum Alloy Casting AC4C • ADC		Copper Alloy C1100					
	S (min ⁻¹)	F (mm/min)	S (min ⁻¹)	F (mm/min)	S (min ⁻¹)	F (mm/min)				
300			300		150					
DC X LU	S (min ⁻¹)	F (mm/min)	S (min ⁻¹)	F (mm/min)	S (min ⁻¹)	F (mm/min)				
3 x 9	32.000	1.720	32.000	1.720	16.000	960				
4 x 12	24.000	1.780	24.000	1.780	12.000	1.030				
5 x 15	19.200	1.840	19.200	1.840	9.600	1.090				
6 x 18	16.000	1.900	16.000	1.900	8.000	1.160				
8 x 24	12.000	2.030	12.000	2.030	6.000	1.300				
10 x 30	9.600	2.150	9.600	2.150	4.800	1.430				
12 x 36	8.000	2.270	8.000	2.270	4.000	1.560				
16 x 48	6.000	2.380	6.000	2.380	3.000	1.630				
20 x 60	4.800	2.490	4.800	2.490	2.400	1.700				
25 x 75	3.850	2.600	3.850	2.600	1.900	1.780				
Depth of cut	<table border="1"> <tr> <td>ap</td> </tr> <tr> <td>1D</td> </tr> </table>				ap	1D	<table border="1"> <tr> <td>ap</td> </tr> <tr> <td>0,5D</td> </tr> </table>		ap	0,5D
ap										
1D										
ap										
0,5D										
<ol style="list-style-type: none"> The above milling condition is a guideline for the overhang length is 4xD. Use a rigid and precise machine and holder. The indicated speeds and feeds are for milling with water-soluble coolant. Please adjust the speed and feed when the cutting depth is large or when machines with low rigidity are used. Reduce speed and feed as well as depth of cut when high precision is required. Adjust the speed and feed accordingly when the overhang length is longer than specified (refer to p.10). Please always use the appropriate cutting fluid recommended by the cutting fluid manufacturer in the machining of magnesium alloys. Be cautious with the cutting chips as they are highly flammable and may pose a serious fire risk if not properly handled. 										

Side Milling

Vc (m/min)	Aluminum Alloy Expanding Material • Magnesium Alloy A5052 • A7075 • AZ91 • AZ80A		Aluminum Alloy Casting AC4C • ADC		Copper Alloy C1100					
	S (min ⁻¹)	F (mm/min)	S (min ⁻¹)	F (mm/min)	S (min ⁻¹)	F (mm/min)				
300			300		150					
DC X LU	S (min ⁻¹)	F (mm/min)	S (min ⁻¹)	F (mm/min)	S (min ⁻¹)	F (mm/min)				
3 x 9	32.000	2.150	32.000	2.150	16.000	1.200				
4 x 12	24.000	2.230	24.000	2.230	12.000	1.290				
5 x 15	19.200	2.300	19.200	2.300	9.600	1.360				
6 x 18	16.000	2.380	16.000	2.380	8.000	1.450				
8 x 24	12.000	2.540	12.000	2.540	6.000	1.620				
10 x 30	9.600	2.690	9.600	2.690	4.800	1.780				
12 x 36	8.000	2.840	8.000	2.840	4.000	1.950				
16 x 48	6.000	2.980	6.000	2.980	3.000	2.040				
20 x 60	4.800	3.100	4.800	3.100	2.400	2.130				
25 x 75	3.850	3.200	3.850	3.200	1.900	2.200				
Depth of cut	<table border="1"> <tr> <td>ap</td> <td>ae</td> </tr> <tr> <td>1,5D</td> <td>0,2D</td> </tr> </table>				ap	ae	1,5D	0,2D		
ap	ae									
1,5D	0,2D									
<ol style="list-style-type: none"> The above milling condition is a guideline for the overhang length is 4xD. Use a rigid and precise machine and holder. The indicated speeds and feeds are for milling with water-soluble coolant. Please adjust the speed and feed when the cutting depth is large or when machines with low rigidity are used. Reduce speed and feed as well as depth of cut when high precision is required. Adjust the speed and feed accordingly when the overhang length is longer than specified (refer to p.10). Please always use the appropriate cutting fluid recommended by the cutting fluid manufacturer in the machining of magnesium alloys. Be cautious with the cutting chips as they are highly flammable and may pose a serious fire risk if not properly handled. 										

Milling | Solid carbide



CUTTING CONDITIONS

Milling | Endmills | Cutting conditions

AE-TS-N Applies to square/sharp corner edge/radius type

Plunging

	Aluminum Alloy Expanding Material • Magnesium Alloy A5052 • A7075 • AZ91 • AZ80A		Aluminum Alloy Casting AC4C • ADC		Copper Alloy C1100	
Vc (m/min)	80		80		60	
DC X LU	S (min ⁻¹)	F (mm/min)	S (min ⁻¹)	F (mm/min)	S (min ⁻¹)	F (mm/min)
3 x 9	8.500	400	8.500	400	6.400	120
4 x 12	6.400	400	6.400	400	4.800	120
5 x 15	5.100	400	5.100	400	3.800	120
6 x 18	4.200	450	4.200	450	3.100	130
8 x 24	3.200	500	3.200	500	2.400	150
10 x 30	2.550	500	2.550	500	1.900	150
12 x 36	2.100	500	2.100	500	1.600	150
16 x 48	1.600	550	1.600	550	1.200	170
20 x 60	1.300	550	1.300	550	960	170
25 x 75	1.020	550	1.020	550	770	170

Depth of cut	<table border="1" style="display: inline-table; margin-right: 20px;"> <tr><td>ap</td></tr> <tr><td>1D</td></tr> </table>				ap	1D	<table border="1" style="display: inline-table;"> <tr><td>ap</td></tr> <tr><td>0,5D</td></tr> </table>		ap	0,5D
ap										
1D										
ap										
0,5D										

1. The above milling condition is a guideline for the overhang length is 4xD.
2. Use a rigid and precise machine and holder.
3. The indicated speeds and feeds are for milling with water-soluble coolant.
4. Please adjust the speed and feed when the cutting depth is large or when machines with low rigidity are used.
5. Reduce speed and feed as well as depth of cut when high precision is required.
6. Adjust the speed and feed accordingly when the overhang length is longer than specified (refer to p.10).
7. When the chips wind around the end mill, reduce the speed and feed.
8. Please always use the appropriate cutting fluid recommended by the cutting fluid manufacturer in the machining of magnesium alloys. Be cautious with the cutting chips as they are highly flammable and may pose a serious fire risk if not properly handled.

Cutting Condition Guide for Changes in Overhang Length

DC = Ø6, Ø8

	Work Material	Aluminum Alloy Expanding Material • Magnesium Alloy A5052 • A7075 • AZ91 • AZ80A		Aluminum Alloy Casting AC4C • ADC		Copper Alloy C1100	
		L/D	S (min ⁻¹)	F (mm/min)	S (min ⁻¹)	F (mm/min)	S (min ⁻¹)
Slot milling	5		70%		70%		70%
	6		40%		40%		40%
Side milling	5		70%		70%		70%
	6		50%		50%		50%
Plunging	5		80%		80%		80%
	6		60%		60%		60%



CUTTING CONDITIONS

Milling | Endmills | Cutting conditions

AE-TL-N Applies to square/sharp corner edge/radius type

3XD Cutting length

Slot Milling

Vc (m/min)	Aluminum Alloy Expanding Material • Magnesium Alloy A5052 • A7075 • AZ91 • AZ80A		Aluminum Alloy Casting AC4C • ADC		Copper Alloy C1100	
	S (min ⁻¹)	F (mm/min)	S (min ⁻¹)	F (mm/min)	S (min ⁻¹)	F (mm/min)
240			240		120	
DC x APMX	S (min ⁻¹)	F (mm/min)	S (min ⁻¹)	F (mm/min)	S (min ⁻¹)	F (mm/min)
3 x 9	25.600	1.380	25.600	1.380	12.800	770
4 x 12	19.200	1.420	19.200	1.420	9.600	820
5 x 15	15.360	1.470	15.360	1.470	7.680	870
6 x 18	12.800	1.520	12.800	1.520	6.400	930
8 x 24	9.600	1.620	9.600	1.620	4.800	1.040
10 x 30	7.680	1.720	7.680	1.720	3.840	1.140
12 x 36	6.400	1.820	6.400	1.820	3.200	1.250
16 x 48	4.800	1.920	4.800	1.920	2.400	1.320
20 x 60	3.800	2.020	3.800	2.020	1.900	1.390
25 x 75	3.060	2.120	3.060	2.120	1.530	1.460
Depth of cut	ap 1D				ap 0,5D	

1. Use a rigid and precise machine and holder.
2. The indicated speeds and feeds are for milling with water-soluble coolant.
3. Please adjust the speed and feed when the cutting depth is large or when machines with low rigidity are used.
4. Reduce speed and feed as well as depth of cut when high precision is required.
5. Please always use the appropriate cutting fluid recommended by the cutting fluid manufacturer in the machining of magnesium alloys. Be cautious with the cutting chips as they are highly flammable and may pose a serious fire risk if not properly handled.

Side Milling

Vc (m/min)	Aluminum Alloy Expanding Material • Magnesium Alloy A5052 • A7075 • AZ91 • AZ80A		Aluminum Alloy Casting AC4C • ADC		Copper Alloy C1100	
	S (min ⁻¹)	F (mm/min)	S (min ⁻¹)	F (mm/min)	S (min ⁻¹)	F (mm/min)
240			240		120	
DC x APMX	S (min ⁻¹)	F (mm/min)	S (min ⁻¹)	F (mm/min)	S (min ⁻¹)	F (mm/min)
3 x 9	25.600	1.720	25.600	1.720	12.800	960
4 x 12	19.200	1.780	19.200	1.780	9.600	1.020
5 x 15	15.360	1.840	15.360	1.840	7.680	1.080
6 x 18	12.800	1.900	12.800	1.900	6.400	1.160
8 x 24	9.600	2.030	9.600	2.030	4.800	1.300
10 x 30	7.680	2.150	7.680	2.150	3.840	1.420
12 x 36	6.400	2.270	6.400	2.270	3.200	1.550
16 x 48	4.800	2.390	4.800	2.390	2.400	1.630
20 x 60	3.800	2.510	3.800	2.510	1.900	1.710
25 x 75	3.060	2.640	3.060	2.640	1.530	1.800
Depth of cut	ap 3D		ae 0,1D			

1. Use a rigid and precise machine and holder.
2. The indicated speeds and feeds are for milling with water-soluble coolant.
3. Please adjust the speed and feed when the cutting depth is large or when machines with low rigidity are used.
4. Reduce speed and feed as well as depth of cut when high precision is required.
5. Please always use the appropriate cutting fluid recommended by the cutting fluid manufacturer in the machining of magnesium alloys. Be cautious with the cutting chips as they are highly flammable and may pose a serious fire risk if not properly handled.



CUTTING CONDITIONS

Milling | Endmills | Cutting conditions

AE-TL-N Applies to square/sharp corner edge/radius type

3XD Cutting length

Plunging

	Aluminum Alloy Expanding Material • Magnesium Alloy A5052 • A7075 • AZ91 • AZ80A		Aluminum Alloy Casting AC4C • ADC		Copper Alloy C1100					
Vc (m/min)	70		70		50					
DC x APMX	S (min ⁻¹)	F (mm/min)	S (min ⁻¹)	F (mm/min)	S (min ⁻¹)	F (mm/min)				
3 x 9	7.500	350	7.500	350	5.300	100				
4 x 12	5.600	350	5.600	350	3.980	100				
5 x 15	4.460	350	4.460	350	3.180	100				
6 x 18	3.680	400	3.680	400	2.650	110				
8 x 24	2.800	450	2.800	450	1.990	120				
10 x 30	2.230	450	2.230	450	1.590	120				
12 x 36	1.840	450	1.840	450	1.330	120				
16 x 48	1.400	500	1.400	500	1.000	130				
20 x 60	1.100	500	1.100	500	800	130				
25 x 75	890	500	890	500	640	130				
Depth of cut	<table border="1"> <tr> <td>ap</td> </tr> <tr> <td>1D</td> </tr> </table>				ap	1D	<table border="1"> <tr> <td>ap</td> </tr> <tr> <td>0,5D</td> </tr> </table>		ap	0,5D
ap										
1D										
ap										
0,5D										

1. Use a rigid and precise machine and holder.
2. The indicated speeds and feeds are for milling with water-soluble coolant.
3. Please adjust the speed and feed when the cutting depth is large or when machines with low rigidity are used.
4. Reduce speed and feed as well as depth of cut when high precision is required.
5. When the chips wind around the end mill, reduce the speed and feed.
6. Please always use the appropriate cutting fluid recommended by the cutting fluid manufacturer in the machining of magnesium alloys. Be cautious with the cutting chips as they are highly flammable and may pose a serious fire risk if not properly handled.

AE-TL-N

5XD Cutting length

Side Milling

	Aluminum Alloy Expanding Material • Magnesium Alloy A5052 • A7075 • AZ91 • AZ80A		Aluminum Alloy Casting AC4C • ADC		Copper Alloy C1100					
Vc (m/min)	100		100		50					
DC x APMX	S (min ⁻¹)	F (mm/min)	S (min ⁻¹)	F (mm/min)	S (min ⁻¹)	F (mm/min)				
3 x 15	10.600	640	10.600	640	5.300	200				
4 x 20	8.000	690	8.000	690	4.000	210				
5 x 25	6.400	730	6.400	730	3.200	230				
6 x 30	5.300	780	5.300	780	2.600	240				
8 x 40	4.000	870	4.000	870	2.000	260				
10 x 50	3.200	960	3.200	960	1.600	290				
12 x 60	2.700	1.050	2.700	1.050	1.300	320				
16 x 60	2.000	1.140	2.000	1.140	1.000	350				
20 x 80	1.600	1.230	1.600	1.230	800	380				
25 x 125	1.300	1.320	1.300	1.320	640	400				
Depth of cut	<table border="1"> <tr> <td>ap</td> <td>ae</td> </tr> <tr> <td>5D</td> <td>0,1D</td> </tr> </table>				ap	ae	5D	0,1D		
ap	ae									
5D	0,1D									

1. Use a rigid and precise machine and holder.
2. The indicated speeds and feeds are for milling with water-soluble coolant.
3. Please adjust the speed and feed when the cutting depth is large or when machines with low rigidity are used.
4. Reduce speed and feed as well as depth of cut when high precision is required.
5. Please always use the appropriate cutting fluid recommended by the cutting fluid manufacturer in the machining of magnesium alloys. Be cautious with the cutting chips as they are highly flammable and may pose a serious fire risk if not properly handled.

Milling | Solid carbide



KEY FEATURES: AE-VTS-N



1 Variable lead and unequal spacing teeth

2 Stable and high efficiency milling is made possible by the suppression of chattering

3 DLC-IGUSS Coating

Due to the smoothness of the coating surface, it is extremely effective for non-ferrous materials such as aluminum alloys that require welding resistance and lubricity. Moreover, tool durability is also improved.



SUITABLE FOR A WIDE RANGE OF APPLICATIONS! HIGH EFFICIENCY AND HIGH QUALITY PROCESSING

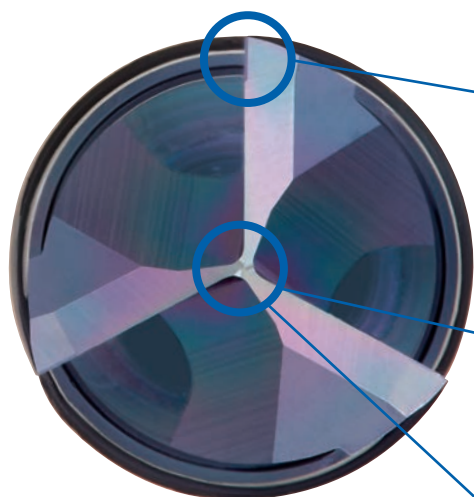

Flat cutting edge

Achieves higher precision machined surface quality

Center cutting edge

Can be used for plunging

3 cutting edges that connect at the center

The cutting load is equalized among the cutting edges with greater stability to enable high speed milling*

*Effective for plunging and ramping

Variable lead and unequal spacing teeth

Stable and high efficiency milling is made possible by the suppression of chattering

Suppression of Vibration

Variable lead and unequal spacing teeth geometry enable stable and high efficiency milling

Variable Leads	Unequal Spacing Teeth
<p>β_1 β_2 $\beta_1 \neq \beta_2$</p>	<p>α_1 α_2 α_3 $\alpha_1 \neq \alpha_2 \neq \alpha_3$</p>



SUITABLE FOR A WIDE RANGE OF APPLICATIONS! HIGH EFFICIENCY AND HIGH QUALITY PROCESSING

Excellent surface finish

Due to the effect of the DLC coating and the flat cutting edge specification, excellent machined surface quality is achieved.

Tool	AE-VTS-N φ10×30	Non-coated Competitor φ10 3 Flutes
Work Material	A7075	
Milling Method	Slot Milling	
Cutting Speed	300m/min (9.550min ⁻¹)	
Feed	1.432mm/min(0.05mm/t)	
Depth of Cut	ap =10mm	
Coolant	Water Soluble	
Machine	Vertical Machining Center (BT40)	

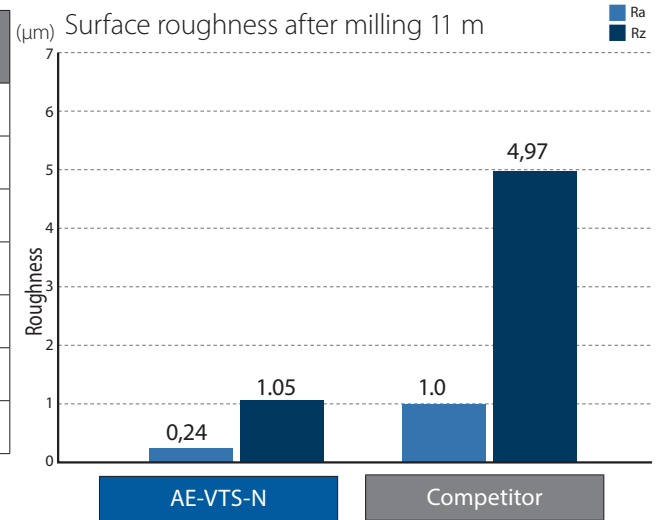

Good machined surface quality even under high speed cutting condition

Due to the anti-welding effect of the DLC coating, the anti-vibration effect of the variable lead and unequal spacing teeth geometry, and the effect of the flat cutting edge specification, good machined surface can be achieved even under aggressive cutting condition.

Tool	AE-VTS-N φ10×30	Non-coated Competitor φ10 3 Flutes
Work Material	A7075	
Milling Method	Slot Milling	
Cutting Speed	408m/min (13.000min ⁻¹)	300m/min (9.550min ⁻¹)
Feed	4.780mm/min (0,123mm/t)	1.432mm/min (0,05mm/t)
Depth of Cut	ap =10mm	
Coolant	Water Soluble	
Machine	Vertical Machining Center (BT40)	

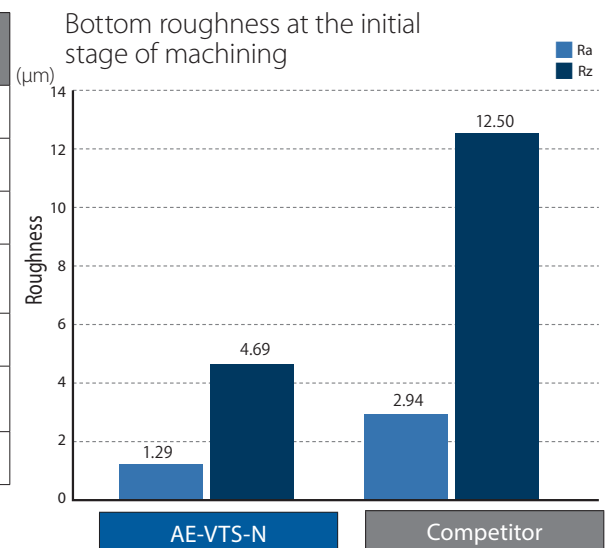

Milling | Solid carbide

AE-VTS-N

Milling | Solid carbide



Type 1

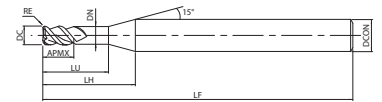

Type 2

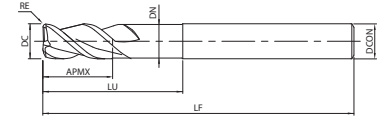

- First choice in quality and performance
- Carbide end mill with DLC IGUSS coating
- For Non-Ferrous Materials
- 3 flutes, variable helix and unequal spacing



EDP	ZEFP	DC	RE	LU	LF	APMX	LH	DCON	DN	Type	Price
8557360	3	3	-	9	55	4,5	14,8	6	2,85	1	
8557400	3	3	0,2	9	55	4,5	14,8	6	2,85	1	
8557401	3	3	0,5	9	55	4,5	14,8	6	2,85	1	
8557361	3	4	-	12	55	6	15,9	6	3,8	1	
8557402	3	4	0,2	12	55	6	15,9	6	3,8	1	
8557403	3	4	0,5	12	55	6	15,9	6	3,8	1	
8557404	3	4	1	12	55	6	15,9	6	3,8	1	
8557362	3	5	-	15	55	7,5	16,8	6	4,8	1	
8557405	3	5	0,2	15	55	7,5	16,8	6	4,8	1	
8557406	3	5	0,5	15	55	7,5	16,8	6	4,8	1	
8557407	3	5	1	15	55	7,5	16,8	6	4,8	1	
8557363	3	6	-	18	60	9	-	6	5,8	2	
8557408	3	6	0,3	18	60	9	-	6	5,8	2	
8557409	3	6	0,5	18	60	9	-	6	5,8	2	
8557410	3	6	1	18	60	9	-	6	5,8	2	
8557364	3	8	-	24	70	12	-	8	7,7	2	
8557411	3	8	0,3	24	70	12	-	8	7,7	2	
8557412	3	8	0,5	24	70	12	-	8	7,7	2	
8557413	3	8	1	24	70	12	-	8	7,7	2	
8557414	3	8	1,5	24	70	12	-	8	7,7	2	
8557415	3	8	2	24	70	12	-	8	7,7	2	
8557365	3	10	-	30	75	15	-	10	9,7	2	
8557416	3	10	0,3	30	75	15	-	10	9,7	2	
8557417	3	10	0,5	30	75	15	-	10	9,7	2	
8557418	3	10	1	30	75	15	-	10	9,7	2	
8557419	3	10	1,5	30	75	15	-	10	9,7	2	
8557420	3	10	2	30	75	15	-	10	9,7	2	
8557421	3	10	3	30	75	15	-	10	9,7	2	
8557366	3	12	-	36	80	18	-	12	11,7	2	
8557422	3	12	0,3	36	80	18	-	12	11,7	2	
8557423	3	12	0,5	36	80	18	-	12	11,7	2	
8557424	3	12	1	36	80	18	-	12	11,7	2	
8557425	3	12	1,5	36	80	18	-	12	11,7	2	
8557426	3	12	2	36	80	18	-	12	11,7	2	
8557427	3	12	3	36	80	18	-	12	11,7	2	

Milling | Solid carbide



AE-VTS-N SP NEW

Milling | Solid carbide



Type 1

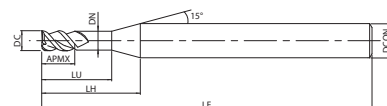

Type 2

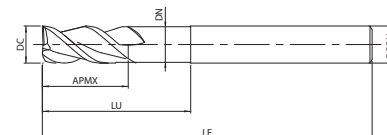

- First choice in quality and performance
- Carbide end mill with DLC-IGUSS coating
- For Non-Ferrous Materials
- 3 flutes, variable helix and unequal spacing
- Sharp corner for milling straight corner



EDP	ZEFP	DC	LU	LF	APMX	LH	DCON	DN	Type	Price
8557460	3	3	9	55	4,5	14,8	6	2,85	1	
8557461	3	4	12	55	6	15,9	6	3,8	1	
8557462	3	5	15	55	7,5	16,8	6	4,8	1	
8557463	3	6	18	60	9		6	5,8	2	
8557464	3	8	24	70	12		8	7,7	2	
8557465	3	10	30	75	15		10	9,7	2	
8557466	3	12	36	80	18		12	11,7	2	

Milling | Solid carbide



Sharp corner edge type for milling straight corners

The sharp corner edge type is designed without a gash land cutting edge specification, enabling it to mill straight corners.

Effective corner milling with no uncut residue left behind.

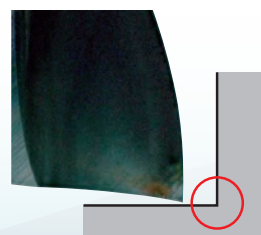

Sharp Corner Edge (SP)

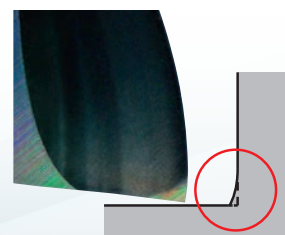

Square Type

CUTTING CONDITIONS

Milling | Endmills | Cutting conditions

AE-VTS-N Applies to square/sharp corner edge/radius type

Slot Milling

Vc (m/min)	Aluminum Alloy Expanding Material • Magnesium Alloy A5052 • A7075 • AZ91 • AZ80A		Aluminum Alloy Casting AC4C • ADC		Copper Alloy C1100					
	S (min ⁻¹)	F (mm/min)	S (min ⁻¹)	F (mm/min)	S (min ⁻¹)	F (mm/min)				
DC X LU										
3 x 9	32.000	3.820	32.000	3.820	16.000	1.430				
4 x 12	24.000	3.960	24.000	3.960	12.000	1.530				
5 x 15	19.200	4.090	19.200	4.090	9.600	1.640				
6 x 18	18.500	4.230	18.500	4.230	9.300	1.740				
8 x 24	16.000	4.510	16.000	4.510	8.000	1.940				
10 x 30	13.000	4.780	13.000	4.780	6.400	2.150				
12 x 36	11.000	5.050	11.000	5.050	5.300	2.360				
Depth of cut	<table border="1"> <tr><td>ap</td></tr> <tr><td>1D</td></tr> </table>				ap	1D	<table border="1"> <tr><td>ap</td></tr> <tr><td>0,5D</td></tr> </table>		ap	0,5D
ap										
1D										
ap										
0,5D										

1. The above milling condition is a guideline for the overhang length is 4xD.
2. Use a rigid and precise machine and holder.
3. The indicated speeds and feeds are for milling with water-soluble coolant.
4. Please adjust the speed and feed when the cutting depth is large or when machines with low rigidity are used.
5. Reduce speed and feed as well as depth of cut when high precision is required.
6. Adjust the speed and feed accordingly when the overhang length is longer than specified (refer to p.18).
7. Please always use the appropriate cutting fluid recommended by the cutting fluid manufacturer in the machining of magnesium alloys. Be cautious with the cutting chips as they are highly flammable and may pose a serious fire risk if not properly handled.

Side Milling

Vc (m/min)	Aluminum Alloy Expanding Material • Magnesium Alloy A5052 • A7075 • AZ91 • AZ80A		Aluminum Alloy Casting AC4C • ADC		Copper Alloy C1100									
	S (min ⁻¹)	F (mm/min)	S (min ⁻¹)	F (mm/min)	S (min ⁻¹)	F (mm/min)								
DC X LU														
3 x 9	32.000	3.820	32.000	3.820	16.000	1.600								
4 x 12	24.000	3.960	24.000	3.960	12.000	1.700								
5 x 15	19.200	4.090	19.200	4.090	9.600	1.830								
6 x 18	18.500	4.230	18.500	4.230	9.300	1.950								
8 x 24	16.000	4.510	16.000	4.510	8.000	2.180								
10 x 30	13.000	4.780	13.000	4.780	6.400	2.400								
12 x 36	11.000	5.050	11.000	5.050	5.300	2.650								
Depth of cut	<table border="1"> <tr><td>ap</td><td>ae</td></tr> <tr><td>1,5D</td><td>0,2D</td></tr> </table>				ap	ae	1,5D	0,2D	<table border="1"> <tr><td>ap</td><td>ae</td></tr> <tr><td>1,5D</td><td>0,1D</td></tr> </table>		ap	ae	1,5D	0,1D
ap	ae													
1,5D	0,2D													
ap	ae													
1,5D	0,1D													

1. The above milling condition is a guideline for the overhang length is 4xD.
2. Use a rigid and precise machine and holder.
3. The indicated speeds and feeds are for milling with water-soluble coolant.
4. Please adjust the speed and feed when the cutting depth is large or when machines with low rigidity are used.
5. Reduce speed and feed as well as depth of cut when high precision is required.
6. Adjust the speed and feed accordingly when the overhang length is longer than specified (refer to p.18).
7. Please always use the appropriate cutting fluid recommended by the cutting fluid manufacturer in the machining of magnesium alloys. Be cautious with the cutting chips as they are highly flammable and may pose a serious fire risk if not properly handled.

Milling | Solid carbide



CUTTING CONDITIONS

Milling | Endmills | Cutting conditions

AE-VTS-N Applies to square/sharp corner edge/radius type

Plunging

	Aluminum Alloy Expanding Material • Magnesium Alloy A5052 • A7075 • AZ91 • AZ80A		Aluminum Alloy Casting AC4C • ADC		Copper Alloy C1100					
Vc (m/min)	150		150		75					
DC X LU	S (min ⁻¹)	F (mm/min)	S (min ⁻¹)	F (mm/min)	S (min ⁻¹)	F (mm/min)				
3 x 9	15.900	500	15.900	500	8.000	150				
4 x 12	12.000	500	12.000	500	6.000	150				
5 x 15	9.600	500	9.600	500	4.800	150				
6 x 18	8.000	600	8.000	600	4.000	180				
8 x 24	6.000	700	6.000	700	3.000	210				
10 x 30	4.800	700	4.800	700	2.400	210				
12 x 36	4.000	700	4.000	700	2.000	210				
Depth of cut	<table border="1"> <tr><td>ap</td></tr> <tr><td>1D</td></tr> </table>			ap	1D	<table border="1"> <tr><td>ap</td></tr> <tr><td>0,5D</td></tr> </table>			ap	0,5D
ap										
1D										
ap										
0,5D										

1. The above milling condition is a guideline for the overhang length is 4xD.
2. Use a rigid and precise machine and holder.
3. The indicated speeds and feeds are for milling with water-soluble coolant.
4. Please adjust the speed and feed when the cutting depth is large or when machines with low rigidity are used.
5. Reduce speed and feed as well as depth of cut when high precision is required.
6. Adjust the speed and feed accordingly when the overhang length is longer than specified.
7. When the chips wind around the end mill, reduce the speed and feed.
8. Please always use the appropriate cutting fluid recommended by the cutting fluid manufacturer in the machining of magnesium alloys. Be cautious with the cutting chips as they are highly flammable and may pose a serious fire risk if not properly handled.

Cutting Condition Guide for Changes in Overhang Length

DC = Ø6, Ø8

	Work Material	Aluminum Alloy Expanding Material • Magnesium Alloy A5052 • A7075 • AZ91 • AZ80A		Aluminum Alloy Casting AC4C • ADC		Copper Alloy C1100	
		L/D	S (min ⁻¹)	F (mm/min)	S (min ⁻¹)	F (mm/min)	S (min ⁻¹)
Slot milling	5		70%		70%		70%
	6		70%	20%	70%	20%	70%
Side milling	5		70%		70%		70%
	6		50%		50%		50%
Plunging	5		80%		80%		80%
	6		60%		60%		60%



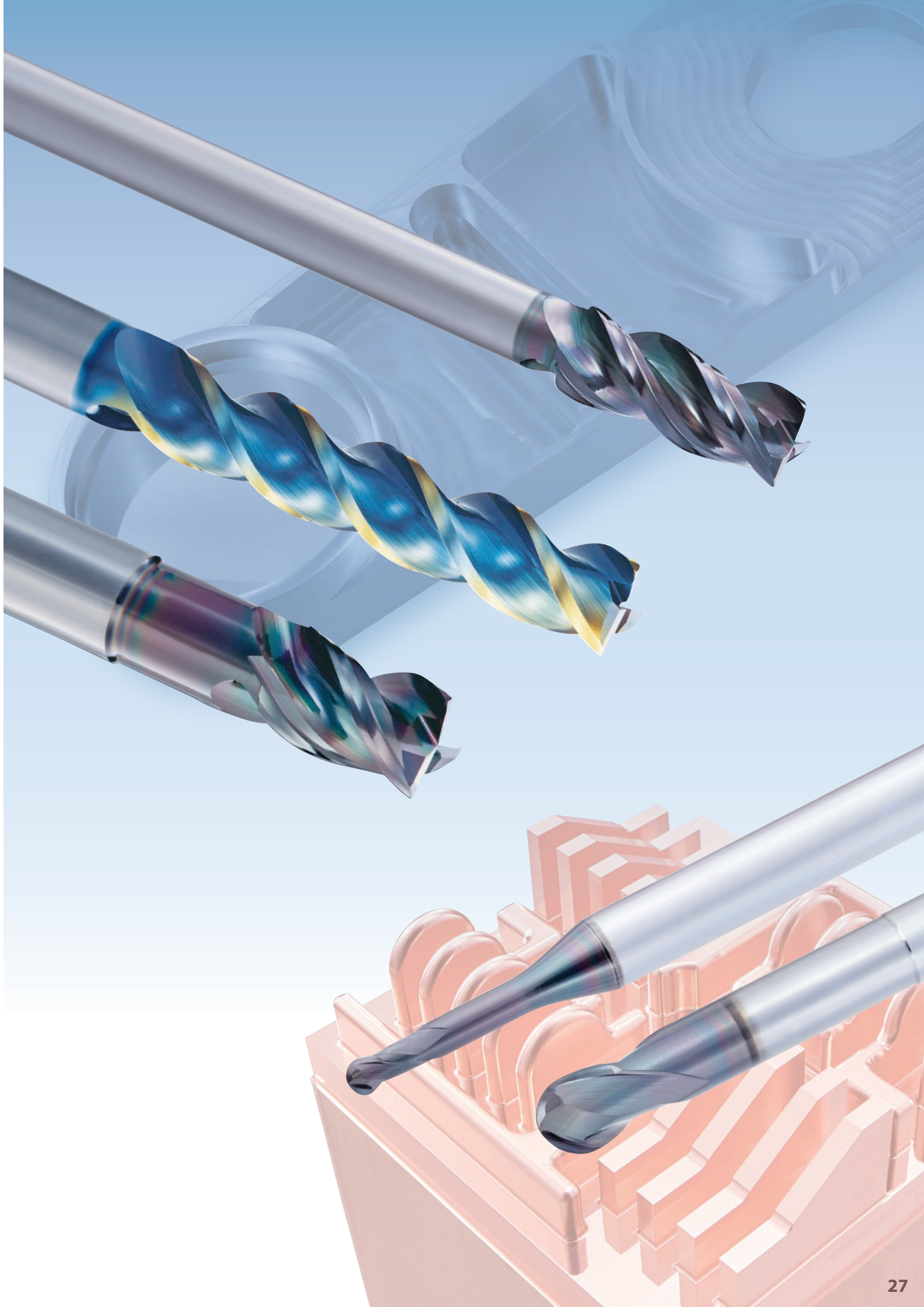

KEY FEATURES: AE-VTFE-N

Highly efficient and highly accurate deep side milling at L/D of 5 or more



2.5×D cutting length

- Highly efficient deep side milling is possible with large step milling of up to 2×D*

The recommended depth of cut varies depending on the overhang length. See p.33 for details.

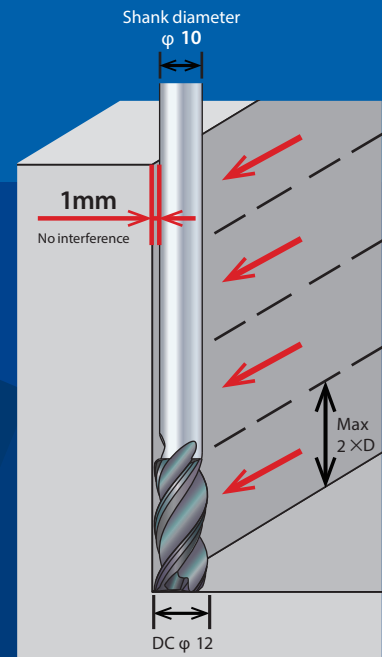

DC > Shank diameter

Long length reduced shank type

- Reduced shank types are tools with an outer diameter that is larger than the shank diameter
- Suitable for deep side milling and pocket milling of non-ferrous metal parts
- Supports various machining depths by changing the overhang length

Flat cutting edge specification

Achieves high quality bottom surface milling with long overhang length

3 cutting edges that connect at the center

The cutting load is equalized among the cutting edges with greater stability

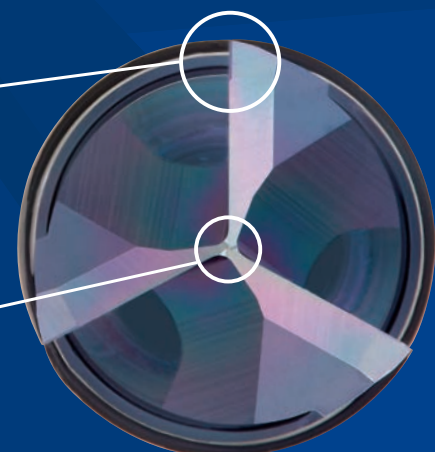

DLC COATED CARBIDE END MILL FOR NON-FERROUS MATERIALS HIGH PERFORMANCE TYPE FOR DEEP SIDE MILLING

High Milling Quality Suppresses streak generation

The R shape on the shank side edge suppresses the generation of streaks due to step milling

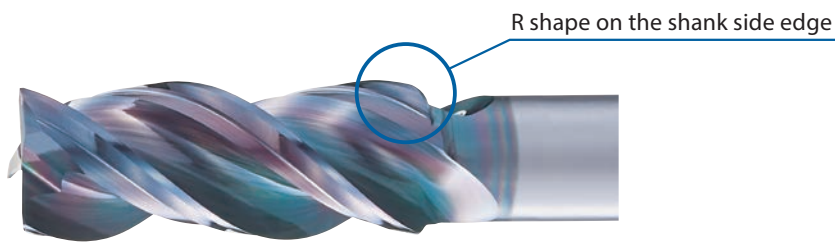

Stable Performance Suppression of vibration

Variable lead and unequal spacing teeth geometry enable stable and high efficiency milling

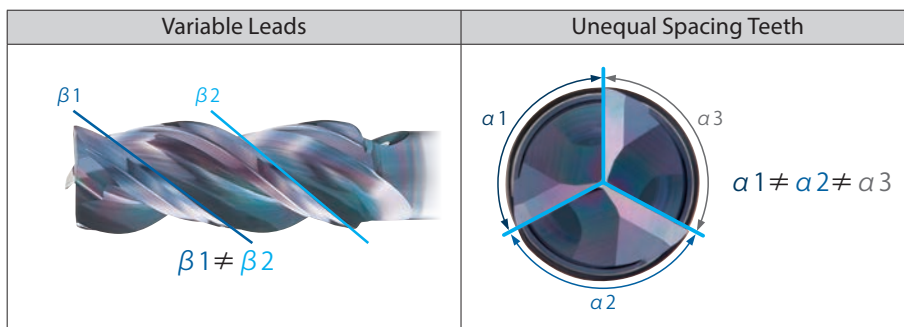

Durability DLC-IGUSS Coating

Due to the smoothness of the coating surface, it is extremely effective for non-ferrous materials such as aluminum alloys that require welding resistance and lubricity. Moreover, tool durability is also improved.



CUTTING DATA

High precision deep side milling

Achieves good accuracy deep side milling at L/D = 8

Tool	AE-VTFE-N Ø12	Competitor Ø12
Work Material	A7075	
Milling Method	Side Step Milling	
Cutting Speed	100 m/min (2.650 min ⁻¹)	
Feed	955mm/min (0,12 mm/t)	
Depth of Cut	ap = 12mm X 7 Times ae = 0,6mm	
Overhang Length	96mm L/D=8	
Coolant	Water Soluble	
Machine	Vertical Machining Center (BT40)	

Comparison of the amount of deflection of the machined surface

The initial stage of machining

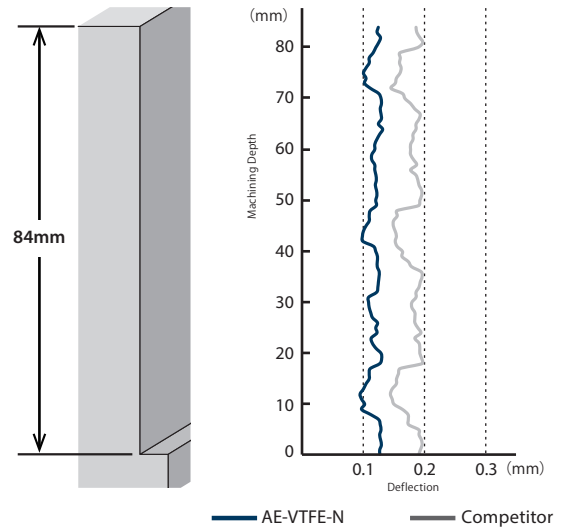

Achieves better machining accuracy compared to conventional long type

Tool	AE-VTFE-N Ø12	Conventional long type Ø12
Work Material	A7075	
Milling Method	Side Step Milling	Side milling
Cutting Speed	200m/min (5.305 min ⁻¹)	100m/min (2.700 min ⁻¹)
Feed	1.910mm/min (0,12 mm/t)	1.050mm/min (0,13 mm/t)
Depth of Cut	ap = 24mm X 2 Times + 12mm ae = 1,2mm	ap = 60mm ae = 1mm
Overhang Length	72mm L/D=6	
Coolant	Water Soluble	
Machine	Vertical Machining Center (BT40)	

Comparison of the amount of deflection of the machined surface

The initial stage of machining

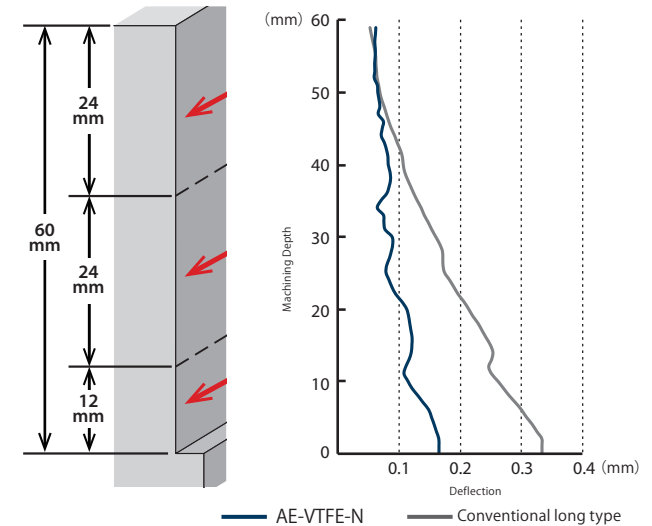

CUTTING DATA

Stable slot milling at L/D=5

Due to the effect of the flat cutting edge specification, excellent machined surface quality is achieved.

Tool	AE-VTFE-N Ø12	Conventional Ø12	Competitor Ø12
Work Material	A5052		
Milling Method	Slot Milling		
Cutting Speed	200m/min (5.305 min ⁻¹)		
Feed	1.910mm/min (0,12 mm/t)		
Depth of Cut	ap = 2,4mm (0,2D)		
Overhang Length	60mm L/D=5		
Coolant	Water Soluble		
Machine	Vertical Machining Center (BT40)		

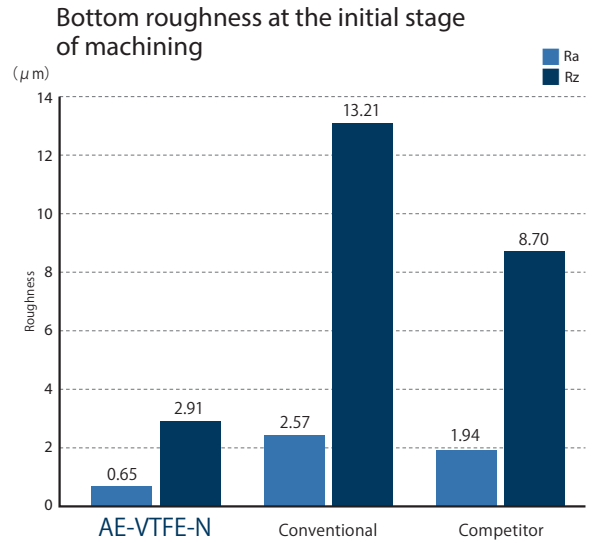

Good machined surface



CUTTING CONDITIONS

Milling | Endmills | Cutting conditions

AE-VTFE-N Applies to square/radius type

Slot Milling

Vc (m/min)	Aluminum Alloy Expanding Material • Magnesium Alloy A5052 • A7075 • AZ91 • AZ80A		Aluminum Alloy Casting AC4C • ADC		Copper Alloy C1100	
	S (min ⁻¹)	F (mm/min)	S (min ⁻¹)	F (mm/min)	S (min ⁻¹)	F (mm/min)
200			200		100	
DC						
6	8.490	1.530	8.490	1.530	4.250	640
8	6.370	1.150	6.370	1.150	3.180	480
10	6.370	1.910	6.370	1.910	3.180	760
12	5.310	1.910	5.310	1.910	2.650	640
14	4.550	1.640	4.550	1.640	2.270	540
18	3.540	1.270	3.540	1.270	1.770	420
22	2.900	1.040	2.900	1.040	1.450	350

Depth of cut		ap
	DC ≤ Ø10	0,1D
	10 < DC	0,2D

- The above milling condition is a guideline for the overhang length is 5xD.
- Use a rigid and precise machine and holder.
- The indicated speeds and feeds are for milling with water-soluble coolant.
- Please adjust the speed and feed when the cutting depth is large or when machines with low rigidity are used.
- Reduce speed and feed as well as depth of cut when high precision is required.
- Adjust the speed and feed accordingly when the overhang length is longer than specified (refer to p.34).
- When the chips wind around the end mill, reduce the speed and feed.
- Please always use the appropriate cutting fluid recommended by the cutting fluid manufacturer in the machining of magnesium alloys. Be cautious with the cutting chips as they are highly flammable and may pose a serious fire risk if not properly handled.

AE-VTFE-N Applies to square/radius type

Side Milling

Vc (m/min)	Aluminum Alloy Expanding Material • Magnesium Alloy A5052 • A7075 • AZ91 • AZ80A		Aluminum Alloy Casting AC4C • ADC		Copper Alloy C1100	
	S (min ⁻¹)	F (mm/min)	S (min ⁻¹)	F (mm/min)	S (min ⁻¹)	F (mm/min)
300			300		150	
DC						
6	15.920	2.870	15.920	2.870	7.960	1.190
8	11.940	2.150	11.940	2.150	5.970	1.070
10	9.550	2.870	9.550	2.870	4.780	1.000
12	7.960	2.870	7.960	2.870	3.980	960
14	6.820	2.460	6.820	2.460	3.410	820
18	5.310	1.910	5.310	1.910	2.650	640
22	4.340	1.560	4.340	1.560	2.170	520

Depth of cut	ap	ae
	2D	0,1D

- The above milling condition is a guideline for the overhang length is 5xD.
- Use a rigid and precise machine and holder.
- The indicated speeds and feeds are for milling with water-soluble coolant.
- Please adjust the speed and feed when the cutting depth is large or when machines with low rigidity are used.
- Reduce speed and feed as well as depth of cut when high precision is required.
- Adjust the speed and feed accordingly when the overhang length is longer than specified (refer to p.34).
- When the chips wind around the end mill, reduce the speed and feed.
- Please always use the appropriate cutting fluid recommended by the cutting fluid manufacturer in the machining of magnesium alloys. Be cautious with the cutting chips as they are highly flammable and may pose a serious fire risk if not properly handled.

Milling | Solid carbide

Cutting Condition Guide for Changes in Overhang Length

Work Material	L/D	Aluminum Alloy Expanding Material • Magnesium Alloy A5052 • A7075 • AZ91 • AZ80A			Aluminum Alloy Casting AC4C • ADC			Copper Alloy C1100					
		S (min ⁻¹)	F (mm/min)	Depth of Cut		S (min ⁻¹)	F (mm/min)	Depth of Cut		S (min ⁻¹)	F (mm/min)	Depth of Cut	
				ap	ae			ap	ae			ap	ae
Slot milling	6	50%	50%	0,015D	-	50%	50%	0,015D	-	50%	50%	0,015D	-
	7	30%	20%	0,01D	-	30%	20%	0,01D	-	30%	20%	0,01D	-
Side milling	6	65%	60%	2D	0,05D	65%	60%	2D	0,05D	90%	90%	2D	0,05D
	7	55%	50%	2D	0,03D	55%	50%	2D	0,03D	70%	70%	2D	0,03D
	8	45%	45%	2D	0,025D	45%	45%	2D	0,025D	65%	65%	2D	0,01D

KEY FEATURES: AE-LNBD-N

Milling beautiful copper electrodes without burrs!

Excellent machined surface accuracy

Beautiful edge without burrs



Ball specifications that enable high quality milling

1 Optimal cutting edge shape for milling copper alloy

2 Superior ball R precision

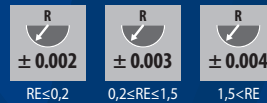

3 High quality primary relief surface

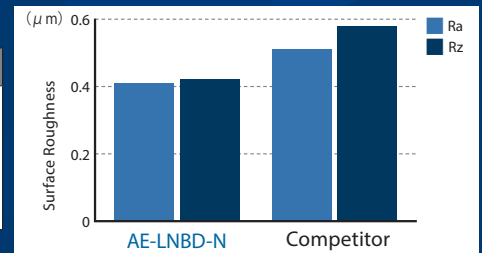
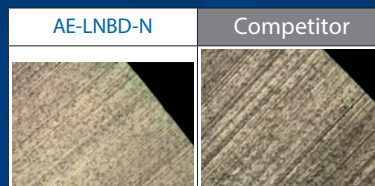

Teardrop-shaped outer periphery

Strong back taper geometry enables milling by point, which prevents chattering and chipping, resulting in improvement of surface accuracy.

Note: Teardrop-shaped specification does not apply to items above R2.

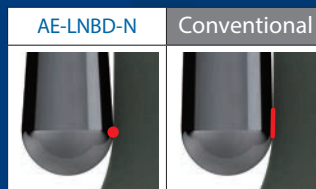

Superior shank accuracy

Supports h4 tolerance (0/0,004)



UNIQUE DLC COATING THAT REVAMPS COPPER ELECTRODE MACHINING

Due to its smooth surface and extremely low coefficient of friction, DLC coating is extremely effective against non-ferrous metals such as copper alloys, which require welding resistance and lubricity.

DLC-IGUSS coating

Name of Coating	Coating Color	Coating Type	(GPa) Hardness	Oxidation Temperature (C°)	Coefficient of Friction	(µm)Coating Thickness	Coating Temperature (C°)	Surface roughness	Wear Resistance	Welding Resistance	Toughness
DLC-IGUSS	Interference Color	DLC(SP ³ Rich)	60	550	0.10	0.8	400	☆	☉	☆	○

(Good) ○ → ☉ → ☆ (Best)

Wear resistance

DLC-IGUSS is effective in suppressing wear against tough-pitch copper (C1100), and stable machining accuracy can be obtained for a long period of time.

Tool	2 Flutes Carbide Ball End Mill
Work Material	C1100
Milling Method	Pick Milling
Cutting Speed	141 m/min (15.000 min ⁻¹)
Feed	1.500mm/min (0,05 mm/t)
Depth of Cut	ap = 1,5mm Pf = 0,05mm
Coolant	Water Soluble
Machine	Vertical Machining Center (BT40)

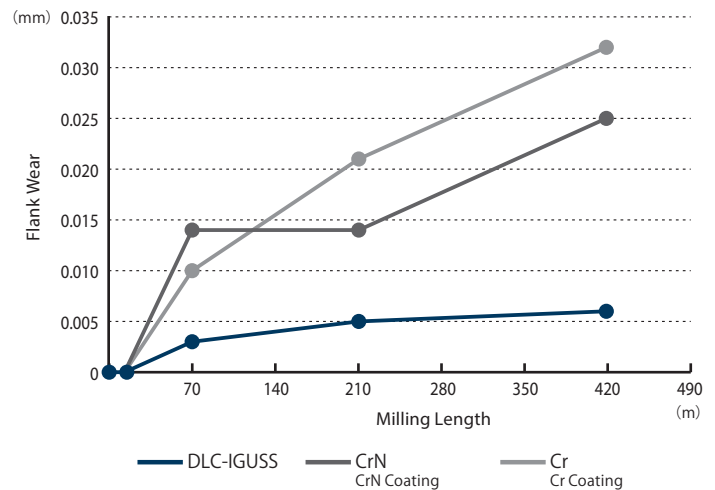

Wear condition of ball flank after milling 420m

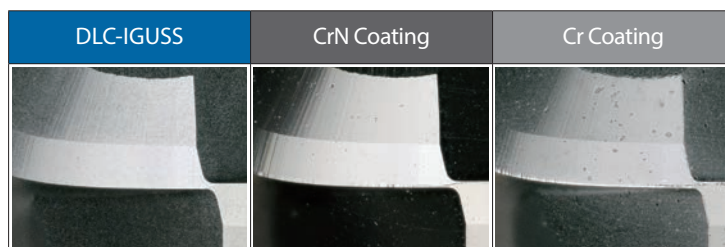

CUTTING DATA

Long Tool Life

DLC-IGUSS coating enables consistent tool wear

Tool	AE-LNBD-N R1X10X4
Work Material	C1100
Milling Method	Pick Milling
Cutting Speed	126m/min (20.000 min ⁻¹)
Feed	2.000mm/min (0,05 mm/t)
Depth of Cut	ap = 0,2mm (0,1D) Pf = 0,4mm (0,2D)
Coolant	Water Soluble
Machine	Horizontal Machining Center (BT40)

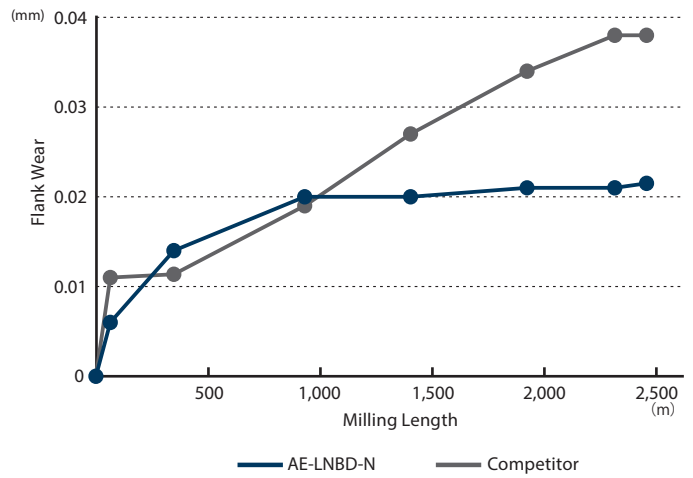

Wear condition of ball flank after milling 2.480m

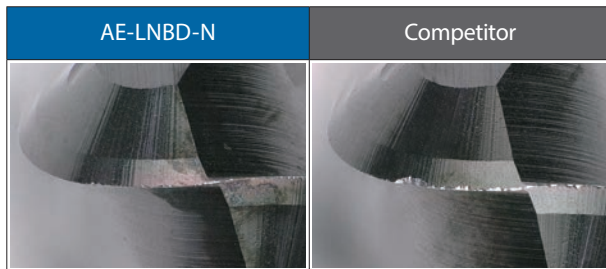

Exhibits superior endurance in copper tungsten

Tool	AE-LNBD-N R1X10X4
Work Material	Copper Tungsten
Milling Method	Pick Milling
Cutting Speed	101m/min (16.000 min ⁻¹)
Feed	1.400mm/min (0,04 mm/t)
Depth of Cut	ap = 0,2mm (0,1D) Pf = 0,4mm (0,2D)
Coolant	Water Soluble
Machine	Horizontal Machining Center (BT40)

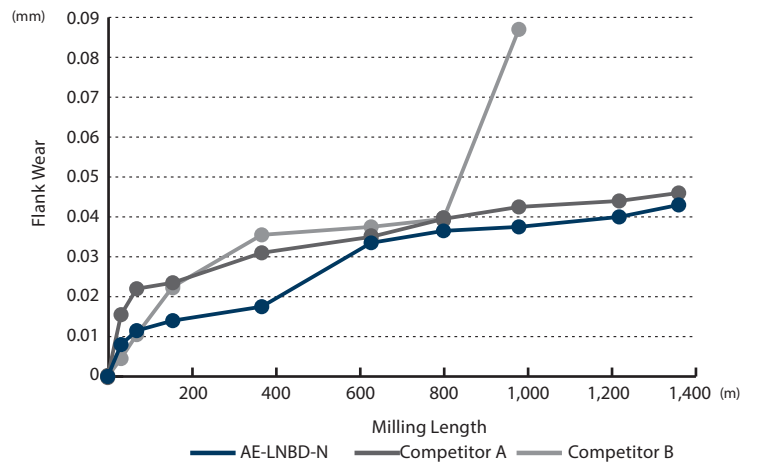

Wear condition of ball flank



Milling | Solid carbide



CUTTING DATA

Achieves good machined surface without burrs compared to conventional products

(C1100)

Work Material : Tough-Pitch Copper

Work Size: 60x60 (Milling Depth 10mm)

(HSK-E32)

Machine : Vertical Machining Center

Coolant: MQL*

Watch it in action



* MQL is used for filming the video.

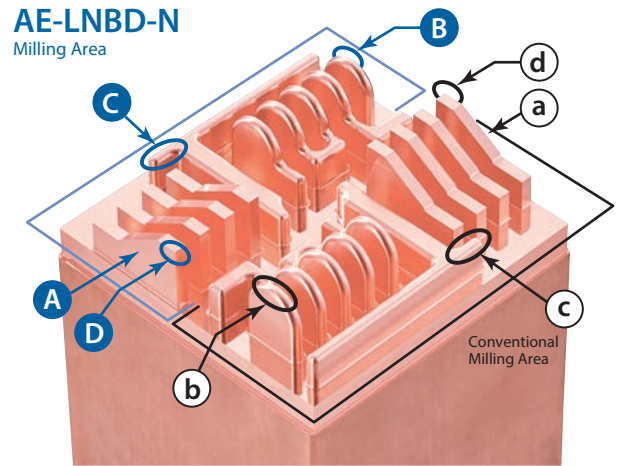

Tool	Process	Condition of Machined Surface			Condition of Burrs
AE-LNBD-N R1x10x4	⑤	A Ra : 0.1125μm	B Tear	C Collapse of Shape	D Burr
Conventional (Cr Coating) R1x10x4	⑥	a Ra : 0.19125μm	b Tear	c Collapse of Shape	d Burr

Process	Milling Part	Milling Process	Tool	Cutting Speed (m/min)	Feed (mm/min)	ap (mm)	Pf (mm)
①	Overall	Contouring Line Long Flute High Efficiency Roughing	AE-TL-N 3x15	50 (5.300min ⁻¹)	600 (0,038mm/t)	11	0,3
②	Overall	Contouring Line Roughing	AE-LNBD-N R1x10x4	105 (16.800min ⁻¹)	1,500 (0,045mm/t)	0,25	0,25
③	Surface Plane	Frontal Milling Semi-roughing	AE-TL-N 3x15	50 (5.300min ⁻¹)	400 (0,025mm/t)	0,1	1
④	Overall	Contouring Line Semi-finishing	AE-LNBD-N R1x10x4	105 (16.800min ⁻¹)	1,500 (0,045mm/t)	0,25	0,25
⑤	Left Shape	Contouring Line High-precision Finishing	AE-LNBD-N R1x10x4	127 (20.160min ⁻¹)	750 (0,019mm/t)	0,03	0,03
⑥	Right Shape	Contouring Line High-precision Finishing	Conventional (Cr Coating) R1x10x4	127 (20.160min ⁻¹)	750 (0,019mm/t)	0,03	0,03



CUTTING DATA

Achieves consistent tool wear over time and machining accuracy compared to conventional products

Work materials of ① and ② are processed under the following cutting conditions

Tool	AE-LNBD-N R0,2X1X4	Conventional (Cr Coating)
Work Material	① Copper Tungsten ② Tough-Pitch Copper	
Milling Method	Contour and High Precision Finishing	
Cutting Speed	Vc=75m/min (60.000 min ⁻¹)	
Feed	Vf=600mm/min (0,005 mm/t)	
Depth of Cut	ap = 0,005mm Pf = 0,005mm	
Coolant	Non-Water Soluble	
Machine	Android II (HSK-E25)	

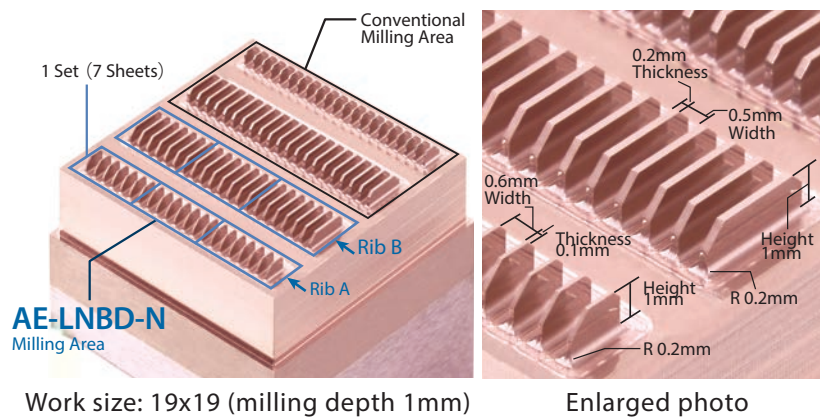

① Machining Copper Tungsten

■ Stable wear transition

52,1m
Wear comparison after milling 52,1 m

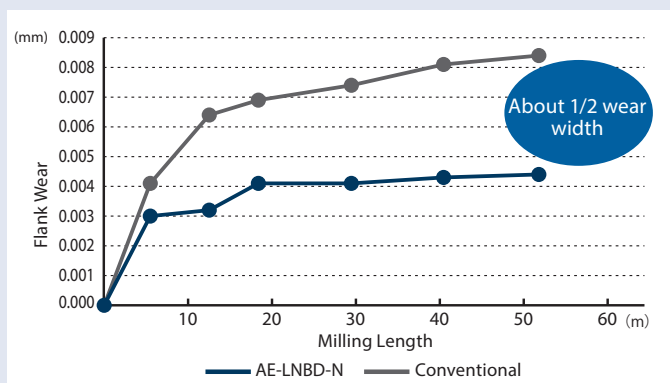
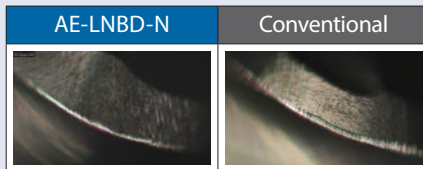

② Machining Tough-Pitch Copper

■ Good edge without burrs

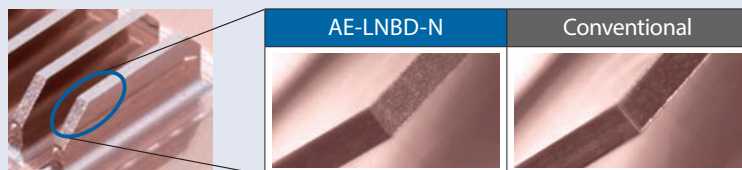

■ Stable machining accuracy with little dimensional change

Evaluation method of cutting test

- ① Milling 1 set of tough-pitch copper ribs (7 sheets)
- ② Dimensional measurement by processing a copper alloy block for dimensional measurement of each set of ribs

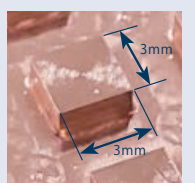

Block of copper alloy for dimensional measurement

Cutting length of 1 set of ribs	
Rib A	Rib B
6,2 m/1set	11,1m/1set

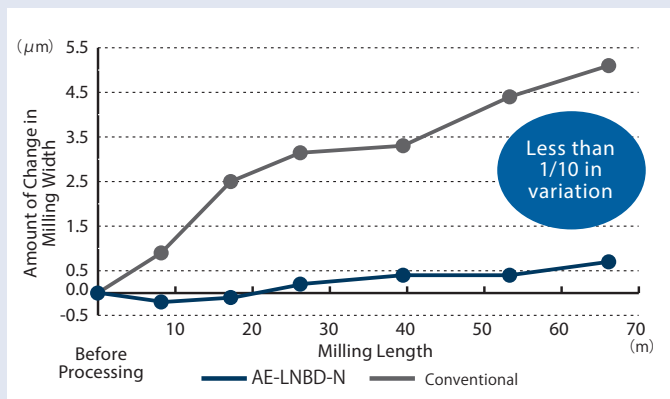

AE-LNBD-N

Milling | Solid carbide



Type 1

Type 2

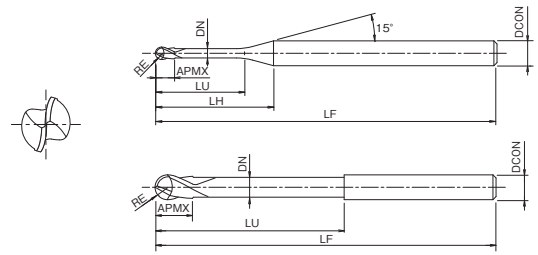

- First choice in quality and performance
- Carbide end mill with DLC IGUSS coating
- For copper electrodes also for aluminium cast and die cast
- 2 flutes, long neck, ball nose
- 72 sizes

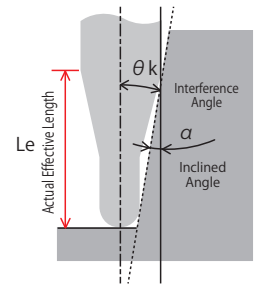

EDP	ZEFP	DC	RE	LU	LF	APMX	LH	DCON	DN	Φk	Effective length by inclined angles Le (α)*					Type	Price
											0,5°	1°	1,5°	2°	3°		
3056370	2	0,1	0,05	0,3	45	0,08	7,6	4	0,09	14,52	0,3	0,31	0,32	0,33	0,36	1	
3056371	2	0,1	0,05	0,5	45	0,08	7,8	4	0,09	14,07	0,53	0,56	0,59	0,62	0,67	1	
3056372	2	0,15	0,075	0,3	45	0,12	7,5	4	0,135	14,55	0,3	0,31	0,32	0,33	0,35	1	
3056373	2	0,15	0,075	0,5	45	0,12	7,7	4	0,135	14,12	0,52	0,55	0,58	0,6	0,65	1	
3056374	2	0,15	0,075	1	45	0,12	8,2	4	0,135	13,29	1,05	1,1	1,14	1,18	1,27	1	
3056375	2	0,2	0,1	0,3	45	0,16	7,4	4	0,19	14,59	0,3	0,31	0,32	0,33	0,34	1	
3056376	2	0,2	0,1	0,5	45	0,16	7,6	4	0,19	14,12	0,53	0,56	0,58	0,61	0,66	1	
3056377	2	0,2	0,1	1	45	0,16	8,1	4	0,19	13,28	1,06	1,11	1,15	1,19	1,28	1	
3056378	2	0,2	0,1	1,5	45	0,16	8,6	4	0,19	12,53	1,58	1,65	1,7	1,76	1,9	1	
3056379	2	0,3	0,15	0,6	45	0,24	7,5	4	0,285	14,02	0,63	0,65	0,68	0,7	0,75	1	
3056380	2	0,3	0,15	1	45	0,24	7,9	4	0,285	13,33	1,05	1,09	1,13	1,17	1,25	1	
3056381	2	0,3	0,15	1,5	45	0,24	8,4	4	0,285	12,56	1,57	1,63	1,68	1,74	1,87	1	
3056382	2	0,3	0,15	2	45	0,24	8,9	4	0,285	11,87	2,09	2,16	2,24	2,32	2,49	1	
3056383	2	0,4	0,2	1	45	0,3	7,7	4	0,38	13,38	1,04	1,08	1,11	1,15	1,23	1	
3056384	2	0,4	0,2	2	45	0,3	8,7	4	0,38	11,87	2,08	2,15	2,22	2,3	2,47	1	
3056385	2	0,4	0,2	3	45	0,3	9,7	4	0,38	10,66	3,12	3,22	3,33	3,45	3,71	1	
3056386	2	0,4	0,2	4	45	0,3	10,7	4	0,38	9,68	4,15	4,29	4,44	4,6	4,95	1	
3056387	2	0,5	0,25	1	45	0,4	7,6	4	0,475	13,43	1,03	1,07	1,1	1,13	1,2	1	
3056388	2	0,5	0,25	2	45	0,4	8,6	4	0,475	11,87	2,07	2,14	2,21	2,28	2,45	1	
3056389	2	0,5	0,25	3	45	0,4	9,6	4	0,475	10,63	3,11	3,21	3,32	3,43	3,69	1	
3056390	2	0,5	0,25	4	45	0,4	10,6	4	0,475	9,63	4,14	4,28	4,42	4,58	4,93	1	
3056391	2	0,5	0,25	5	45	0,4	11,6	4	0,475	8,79	5,18	5,35	5,53	5,73	6,18	1	
3056392	2	0,6	0,3	1	45	0,5	7,3	4	0,55	13,5	1,02	1,05	1,07	1,1	1,17	1	
3056393	2	0,6	0,3	2	45	0,5	8,3	4	0,55	11,89	2,06	2,12	2,18	2,25	2,41	1	
3056394	2	0,6	0,3	3	45	0,5	9,3	4	0,55	10,62	3,09	3,19	3,29	3,4	3,66	1	
3056395	2	0,6	0,3	4	45	0,5	10,3	4	0,55	9,59	4,12	4,26	4,4	4,55	4,9	1	
3056396	2	0,6	0,3	5	45	0,5	11,3	4	0,55	8,74	5,16	5,33	5,51	5,7	6,14	1	
3056397	2	0,6	0,3	6	45	0,5	12,3	4	0,55	8,02	6,19	6,4	6,62	6,85	7,39	1	
3056398	2	0,8	0,4	2	45	0,6	8	4	0,75	11,87	2,05	2,11	2,17	2,24	2,39	1	
3056399	2	0,8	0,4	3	45	0,6	9,1	4	0,75	10,53	3,09	3,18	3,28	3,39	3,63	1	
3056400	2	0,8	0,4	4	45	0,6	10	4	0,75	9,46	4,12	4,25	4,39	4,54	4,88	1	
3056401	2	0,8	0,4	6	45	0,6	12	4	0,75	7,86	6,19	6,39	6,61	6,84	7,36	1	
3056402	2	0,8	0,4	8	45	0,6	14	4	0,75	6,72	8,25	8,53	8,82	9,14	9,85	1	
3056403	2	1	0,5	2	45	0,8	7,6	4	0,95	11,85	2,05	2,1	2,16	2,22	2,37	1	
3056404	2	1	0,5	3	45	0,8	8,6	4	0,95	10,44	3,08	3,17	3,27	3,37	3,61	1	
3056405	2	1	0,5	4	45	0,8	9,6	4	0,95	9,32	4,12	4,24	4,38	4,52	4,85	1	
3056406	2	1	0,5	5	45	0,8	10,6	4	0,95	8,42	5,15	5,31	5,49	5,67	6,1	1	
3056407	2	1	0,5	6	45	0,8	11,6	4	0,95	7,68	6,18	6,38	6,59	6,82	7,34	1	
3056408	2	1	0,5	8	45	0,8	13,6	4	0,95	6,52	8,25	8,52	8,81	9,12	9,83	1	
3056409	2	1	0,5	10	45	0,8	15,6	4	0,95	5,67	10,32	10,66	11,03	11,42	12,31	1	
3056410	2	1	0,5	12	45	0,8	17,6	4	0,95	5,01	12,39	12,8	13,24	13,72	14,8	1	
3056411	2	1,5	0,75	4	45	1,2	8,8	4	1,45	8,8	4,18	4,33	4,46	4,6	4,92	1	
3056412	2	1,5	0,75	6	45	1,2	10,8	4	1,45	7,09	6,27	6,47	6,68	6,9	7,4	1	
3056413	2	1,5	0,75	12	55	1,2	16,8	4	1,45	4,46	12,48	12,89	13,33	13,8	14,86	1	

* If there is no value in the actual effective length (Le column) for the work gradient angle α, it indicates no interference.



AE-LNBD-N

Milling | Solid carbide



Type 1

Type 2

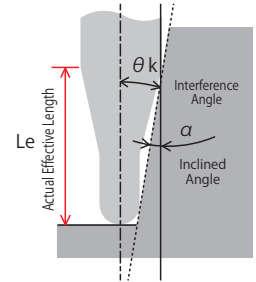
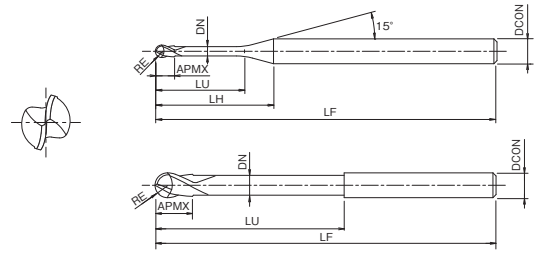

- First choice in quality and performance
- Carbide end mill with DLC IGUSS coating
- For copper electrodes also for aluminium cast and die cast
- 2 flutes, long neck, ball nose
- 72 sizes



EDP	ZEFP	DC	RE	LU	LF	APMX	LH	DCON	DN	Φk	Effective length by inclined angles Le (α)*					Type	Price
											0,5°	1°	1,5°	2°	3°		
3056414	2	1,5	0,75	18	55	1,2	22,8	4	1,45	3,25	18,68	19,31	19,98	20,7	22,32	1	
3056415	2	2	1	4	50	1,6	8,2	4	1,95	7,88	4,22	4,44	4,65	4,86	5,26	1	
3056416	2	2	1	6	50	1,6	10,2	4	1,95	6,2	6,35	6,67	6,96	7,23	7,75	1	
3056417	2	2	1	8	50	1,6	12,2	4	1,95	5,1	8,47	8,87	9,22	9,54	10,24	1	
3056418	2	2	1	10	50	1,6	14,2	4	1,95	4,34	10,58	11,05	11,45	11,84	12,73	1	
3056419	2	2	1	12	50	1,6	16,2	4	1,95	3,77	12,68	13,21	13,67	14,14	15,21	1	
3056420	2	2	1	14	50	1,6	18,2	4	1,95	3,33	14,78	15,36	15,88	16,44	17,7	1	
3056421	2	2	1	16	50	1,6	20,2	4	1,95	2,99	16,87	17,5	18,1	18,74	-	1	
3056422	2	2	1	20	60	1,6	24,2	4	1,95	2,47	21,04	21,78	22,53	23,34	-	1	
3056423	2	2	1	25	60	1,6	29,2	4	1,95	2,04	26,24	27,13	28,07	29,09	-	1	
3056424	2	3	1,5	10	55	2,4	15,8	6	2,85	5,95	10,44	10,83	11,18	11,55	12,37	1	
3056425	2	3	1,5	12	55	2,4	17,8	6	2,85	5,23	12,53	12,98	13,4	13,85	14,85	1	
3056426	2	3	1,5	14	55	2,4	19,8	6	2,85	4,67	14,62	15,12	15,62	16,15	17,34	1	
3056427	2	3	1,5	16	55	2,4	21,8	6	2,85	4,21	16,7	17,26	17,83	18,45	19,83	1	
3056428	2	3	1,5	20	55	2,4	25,8	6	2,85	3,53	20,85	21,54	22,27	23,05	24,8	1	
3056429	2	3	1,5	25	65	2,4	30,8	6	2,85	2,93	26,03	26,89	27,81	28,8	-	1	
3056430	2	3	1,5	30	65	2,4	35,8	6	2,85	2,5	31,2	32,24	33,35	34,54	-	1	
3056431	2	4	2	10	60	3,2	14	6	3,85	4,75	10,42	10,79	11,13	11,47	12,25	1	
3056432	2	4	2	15	60	3,2	19	6	3,85	3,37	15,64	16,16	16,67	17,22	18,47	1	
3056433	2	4	2	20	65	3,2	24	6	3,85	2,61	20,84	21,51	22,21	22,97	-	1	
3056434	2	4	2	25	65	3,2	29	6	3,85	2,13	26,02	26,85	27,75	28,72	-	1	
3056435	2	4	2	30	80	3,2	34	6	3,85	1,79	31,18	32,2	33,3	-	-	1	
3056436	2	4	2	40	80	3,2	44	6	3,85	1,37	41,52	42,9	-	-	-	1	
3056437	2	6	3	10	70	4,8	-	6	5,85	-	-	-	-	-	-	2	
3056438	2	6	3	15	70	4,8	-	6	5,85	-	-	-	-	-	-	2	
3056439	2	6	3	20	70	4,8	-	6	5,85	-	-	-	-	-	-	2	
3056440	2	6	3	30	90	4,8	-	6	5,85	-	-	-	-	-	-	2	
3056441	2	6	3	50	90	4,8	-	6	5,85	-	-	-	-	-	-	2	

* If there is no value in the actual effective length (Le column) for the work gradient angle α, it indicates no interference.

Milling | Solid carbide

CUTTING CONDITIONS

Milling | Endmills | Cutting conditions

AE-LNBD-N

Work Material		Wrought aluminium alloy A7075				Aluminium alloy casting · Die casting <Si 13%				Copper C1020 - C1100				Copper Tungsten W70% - Cu30%			
RE	LU (mm)	S (min ⁻¹)	F (mm/min)	Depth of cut (mm)		S (min ⁻¹)	F (mm/min)	Depth of cut (mm)		S (min ⁻¹)	F (mm/min)	Depth of cut (mm)		S (min ⁻¹)	F (mm/min)	Depth of cut (mm)	
				ap	pf			ap	pf			ap	pf			ap	pf
R0,05	0,3	50.000	293	0,005	0,01	43.800	257	0,005	0,01	38.400	225	0,005	0,01	32.000	120	0,005	0,008
R0,05	0,5	50.000	234	0,005	0,01	43.800	205	0,005	0,01	38.400	180	0,005	0,01	32.000	96	0,005	0,008
R0,075	0,3	50.000	335	0,008	0,02	43.800	293	0,008	0,02	38.400	257	0,008	0,02	32.000	137	0,008	0,015
R0,075	0,5	50.000	293	0,008	0,02	43.800	257	0,008	0,02	38.400	225	0,008	0,02	32.000	120	0,008	0,021
R0,075	1	50.000	234	0,005	0,01	43.800	205	0,005	0,01	38.400	180	0,005	0,01	32.000	96	0,005	0,011
R0,1	0,3	50.000	586	0,020	0,04	43.800	513	0,02	0,04	38.400	450	0,02	0,04	32.000	240	0,02	0,03
R0,1	0,5	50.000	586	0,020	0,04	43.800	513	0,02	0,04	38.400	450	0,02	0,04	32.000	240	0,02	0,03
R0,1	1	50.000	293	0,020	0,04	43.800	257	0,02	0,04	38.400	225	0,02	0,04	32.000	120	0,02	0,03
R0,1	1,5	50.000	293	0,020	0,04	43.800	257	0,02	0,04	38.400	225	0,02	0,04	32.000	120	0,02	0,03
R0,15	0,6	50.000	1.172	0,020	0,06	43.800	1.027	0,02	0,06	38.400	900	0,02	0,06	32.000	480	0,02	0,045
R0,15	1	50.000	879	0,020	0,06	43.800	770	0,02	0,06	38.400	675	0,02	0,06	32.000	360	0,02	0,045
R0,15	1,5	50.000	879	0,020	0,06	43.800	770	0,02	0,06	38.400	675	0,02	0,06	32.000	360	0,02	0,045
R0,15	2	50.000	879	0,020	0,06	43.800	770	0,02	0,06	38.400	675	0,02	0,06	32.000	360	0,02	0,045
R0,2	1	50.000	1.172	0,025	0,1	43.800	1.027	0,025	0,1	38.400	900	0,025	0,1	32.000	480	0,025	0,075
R0,2	2	41.300	860	0,025	0,1	37.000	771	0,025	0,1	32.400	675	0,025	0,1	27.000	360	0,025	0,075
R0,2	3	41.300	860	0,025	0,1	37.000	771	0,025	0,1	32.400	675	0,025	0,1	27.000	360	0,025	0,075
R0,2	4	41.300	860	0,01	0,06	37.000	771	0,01	0,06	32.400	675	0,01	0,06	27.000	360	0,01	0,045
R0,25	1	50.000	1.465	0,04	0,1	43.800	1.283	0,04	0,1	38.400	1.125	0,04	0,1	32.000	600	0,04	0,075
R0,25	2	50.000	1.172	0,04	0,1	43.800	1.027	0,04	0,1	38.400	900	0,04	0,1	32.000	480	0,04	0,075
R0,25	3	41.300	860	0,04	0,1	37.000	771	0,04	0,1	32.400	675	0,04	0,1	27.000	360	0,04	0,075
R0,25	4	41.300	860	0,04	0,1	37.000	771	0,04	0,1	32.400	675	0,04	0,1	27.000	360	0,04	0,075
R0,25	5	32.100	573	0,04	0,1	28.700	513	0,04	0,1	25.200	450	0,04	0,1	21.000	240	0,04	0,075
R0,3	1	50.000	2.930	0,09	0,12	43.800	2.566	0,09	0,12	38.400	2.250	0,09	0,12	32.000	1.440	0,09	0,12
R0,3	2	50.000	2.198	0,09	0,12	43.800	1.925	0,09	0,12	38.400	1.688	0,09	0,12	32.000	1.080	0,09	0,12
R0,3	3	46.000	1.199	0,09	0,12	41.000	1.068	0,09	0,12	36.000	938	0,09	0,12	30.000	600	0,09	0,12
R0,3	4	45.900	1.196	0,09	0,12	41.000	1.068	0,09	0,12	36.000	938	0,09	0,12	30.000	600	0,09	0,12
R0,3	5	45.900	1.196	0,09	0,12	41.000	1.068	0,09	0,12	36.000	938	0,09	0,12	30.000	600	0,09	0,12
R0,3	6	38.300	719	0,09	0,12	34.000	638	0,09	0,12	30.000	563	0,09	0,12	25.000	360	0,09	0,12
R0,4	2	41.300	2.152	0,12	0,16	37.000	1.928	0,12	0,16	32.400	1.688	0,12	0,16	27.000	1.080	0,12	0,16
R0,4	3	41.300	2.152	0,12	0,16	37.000	1.928	0,12	0,16	32.400	1.688	0,12	0,16	27.000	1.080	0,12	0,16
R0,4	4	41.300	2.152	0,12	0,16	37.000	1.928	0,12	0,16	32.400	1.688	0,12	0,16	27.000	1.080	0,12	0,16
R0,4	6	36.700	1.195	0,12	0,12	32.800	1.068	0,12	0,12	28.800	938	0,12	0,12	24.000	600	0,12	0,12
R0,4	8	33.700	719	0,12	0,12	30.100	642	0,12	0,12	26.400	563	0,12	0,12	22.000	360	0,12	0,12
R0,5	2	42.800	2.388	0,15	0,2	38.300	2.137	0,15	0,2	33.600	1.875	0,15	0,2	28.000	1.200	0,15	0,2
R0,5	3	42.800	2.388	0,15	0,2	38.300	2.137	0,15	0,2	33.600	1.875	0,15	0,2	28.000	1.200	0,15	0,2
R0,5	4	42.800	2.388	0,15	0,2	38.300	2.137	0,15	0,2	33.600	1.875	0,15	0,2	28.000	1.200	0,15	0,2
R0,5	5	32.100	1.433	0,15	0,2	28.700	1.281	0,15	0,2	25.200	1.125	0,15	0,2	21.000	720	0,15	0,2
R0,5	6	32.100	1.433	0,15	0,2	28.700	1.281	0,15	0,2	25.200	1.125	0,15	0,2	21.000	720	0,15	0,2
R0,5	8	32.100	1.433	0,15	0,15	28.700	1.281	0,15	0,15	25.200	1.125	0,15	0,15	21.000	720	0,15	0,15
R0,5	10	27.500	955	0,12	0,12	24.600	854	0,12	0,12	21.600	750	0,12	0,12	18.000	480	0,12	0,12
R0,5	12	27.500	955	0,12	0,12	24.600	854	0,12	0,12	21.600	750	0,12	0,12	18.000	480	0,12	0,12
R0,75	4	30.600	2.869	0,24	0,3	27.400	2.569	0,24	0,3	24.000	2.250	0,24	0,3	20.000	1.440	0,24	0,3
R0,75	6	27.500	2.387	0,24	0,3	24.600	2.135	0,24	0,3	21.600	1.875	0,24	0,3	18.000	1.200	0,24	0,3
R0,75	12	26.000	1.434	0,24	0,24	23.300	1.285	0,24	0,24	20.400	1.125	0,24	0,24	17.000	720	0,24	0,24
R0,75	18	19.900	957	0,18	0,18	17.800	856	0,18	0,18	15.600	750	0,18	0,18	13.000	480	0,18	0,18
R1	4	25.200	3.341	0,3	0,56	22.600	2.996	0,3	0,56	19.800	2.625	0,3	0,56	16.500	1.680	0,27	0,56
R1	6	25.200	3.341	0,3	0,56	22.600	2.996	0,3	0,56	19.800	2.625	0,3	0,56	16.500	1.680	0,27	0,56
R1	8	25.200	3.341	0,3	0,56	22.600	2.996	0,3	0,56	19.800	2.625	0,3	0,56	16.500	1.680	0,27	0,56
R1	10	21.400	2.388	0,3	0,56	19.200	2.143	0,3	0,56	16.800	1.875	0,3	0,56	14.000	1.200	0,27	0,56
R1	12	21.400	2.388	0,3	0,56	19.200	2.143	0,3	0,56	16.800	1.875	0,3	0,56	14.000	1.200	0,27	0,56
R1	14	21.400	2.388	0,3	0,56	19.200	2.143	0,3	0,56	16.800	1.875	0,3	0,56	14.000	1.200	0,27	0,56
R1	16	21.400	2.388	0,3	0,42	19.200	2.143	0,3	0,42	16.800	1.875	0,3	0,42	14.000	1.200	0,27	0,42
R1	20	16.800	1.194	0,3	0,42	15.000	1.066	0,3	0,42	13.200	938	0,3	0,42	11.000	600	0,27	0,42
R1	25	16.800	1.194	0,3	0,42	15.000	1.066	0,3	0,42	13.200	938	0,3	0,42	11.000	600	0,27	0,42
R1,5	10	18.400	2.875	0,4	0,84	16.400	2.563	0,4	0,84	14.400	2.250	0,4	0,84	12.000	1.440	0,36	0,84
R1,5	12	15.300	2.869	0,4	0,84	13.700	2.569	0,4	0,84	12.000	2.250	0,4	0,84	10.000	1.440	0,36	0,84
R1,5	14	15.300	2.869	0,4	0,84	13.700	2.569	0,4	0,84	12.000	2.250	0,4	0,84	10.000	1.440	0,36	0,84
R1,5	16	15.300	1.434	0,4	0,84	13.700	1.284	0,4	0,84	12.000	1.125	0,4	0,84	10.000	720	0,36	0,84
R1,5	20	15.300	1.434	0,4	0,84	13.700	1.284	0,4	0,84	12.000	1.125	0,4	0,84	10.000	720	0,36	0,84
R1,5	25	15.300	1.434	0,4	0,84	13.700	1.284	0,4	0,84	12.000	1.125	0,4	0,84	10.000	720	0,36	0,84
R1,5	30	13.800	1.199	0,4	0,84	12.300	1.068	0,4	0,84	10.800	938	0,4	0,84	9.000	600	0,36	0,84
R2	10	13.800	3.833	1,0	1,28	12.300	3.417	1	1,28	10.800	3.000	1,0	1,3	9.000	1.920	0,9	1,3
R2	15	13.800	2.875	1,0	1,28	12.300	2.563	1	1,28	10.800	2.250	1,0	1,3	9.000	1.440	0,9	1,3
R2	20	10.700	1.911	1,0	1,28	9.600	1.714	1	1,28	8.400	1.500	1,0	1,3	7.000	960	0,9	1,3
R2	25	10.700	1.911	1,0	1,28	9.600	1.714	1	1,28	8.400	1.500	1,0	1,3	7.000	960	0,9	1,3
R2	30	10.700	1.911	0,8	1,28	9.600	1.714	0,8	1,28	8.400	1.500	0,8	1,3	7.000	960	0,7	1,3
R2	40	7.700	1.204	0,7	1,28	6.800	1.063	0,7	1,28	6.000	938	0,7	1,3	5.000	600	0,6	1,3
R3	10	13.800	4.313	1,2	1,8	12.300	3.844	1,2	1,8	10.800	3.375	1,2	1,8	9.000	2.160	1,1	1,8
R3	15	13.800	4.313	1,2	1,8	12.300	3.844	1,2	1,8	10.800	3.375	1,2	1,8	9.000	2.160	1,1	1,8
R3	20	10.700	2.388	1,2	1,8	9.600	2.143										

KEY FEATURES: PXAL



1 Suitable for large-diameter milling with high surface quality

2 Exchangeable Head End Mill PXM for Non-Ferrous Materials

3 DLC-IGUSS Coating



Due to the smoothness of the coating surface, it is extremely effective for non-ferrous materials such as aluminum alloys that require welding resistance and lubricity. Moreover, tool durability is also improved.

SUITABLE FOR LARGE-DIAMETER MILLING WITH HIGH SURFACE QUALITY

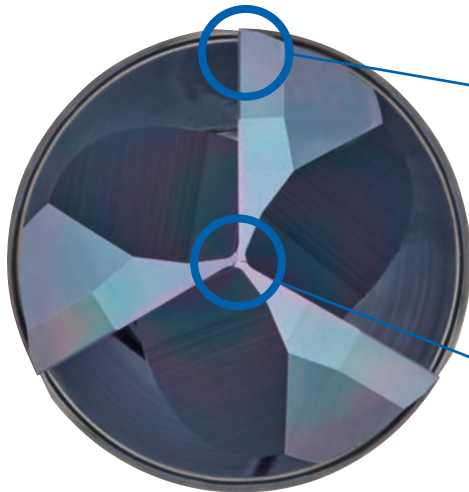

Flat cutting edge

Achieves higher precision machined surface quality

Large core design

High rigidity prevents chattering

Center cutting edge

Can be used for plunging

Utilizes XP4625 grade suitable for non-ferrous metal applications

By adopting a grade optimal for non-ferrous materials such as aluminum alloy, excellent wear resistance, welding resistance, and long tool life can be achieved.

Abundant lineup in various shapes and styles

An abundant lineup including square type, radius type, and reduced shank type are available to accommodate a wide range of applications.

Tightening procedure

1. Cleaning
Remove dirt and chips from the connecting thread and shank.

2. Initial Tightening
Tighten by hand

3. Final Tightening
Tighten with a spanner wrench

4. Confirmation
Confirm that there is no gap

Cautions during use

- Only use the spanner wrenches that are designed specifically for the PXM (P. 13). Please do not use alternative spanner wrenches sold on the market as a replacement.
- Please tighten until the head and the shank holder faces meet. Confirm that there is no gap.
- Degreasing the connecting thread may result in over tightening or a possible separation of the faces. Please do not degrease.
- Please make sure that the spanner wrench is inserted properly and turn it slowly during use.



CUTTING DATA

Improved surface roughness by the effect of the flat cutting edge specification

Tool	Head: PXAL160C16-03R000 Holder: PXMZ-C16SS16-S100	Non-coated Competitor A, B, C
Size	Ø16	Ø16 3 flutes
Work Material	A7075	
Milling Method	Side Milling	
Cutting Speed	600m/min (12.000min ⁻¹)	
Feed	5.400mm/min(0.15mm/t)	
Depth of Cut	ap =8mm (0,5D) ae=4,8mm (0,3D)	
Overhang Length	50mm (L/D= 3,1)	
Coolant	Water Soluble	
Machine	Vertical Machining Center (BT40)	

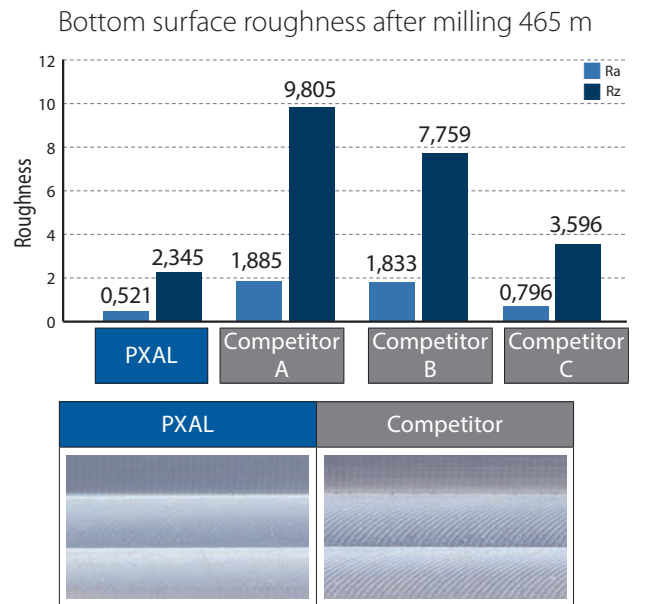

Achieves good surface finish regardless of coolant type

Tool	Head: PXAL160C16-03R000 Holder: PXMZ-C16SS16-S100	Non-coated Competitor
Size	Ø16	Ø16 3 flutes
Work Material	A7075	
Milling Method	Side Milling	
Cutting Speed	600m/min (12.000min ⁻¹)	
Feed	2.700mm/min(0.075mm/t)	
Depth of Cut	ap =8mm (0,5D) ae=4,8mm (0,3D)	
Overhang Length	50mm (L/D= 3,1)	
Machine	Vertical Machining Center (BT40)	

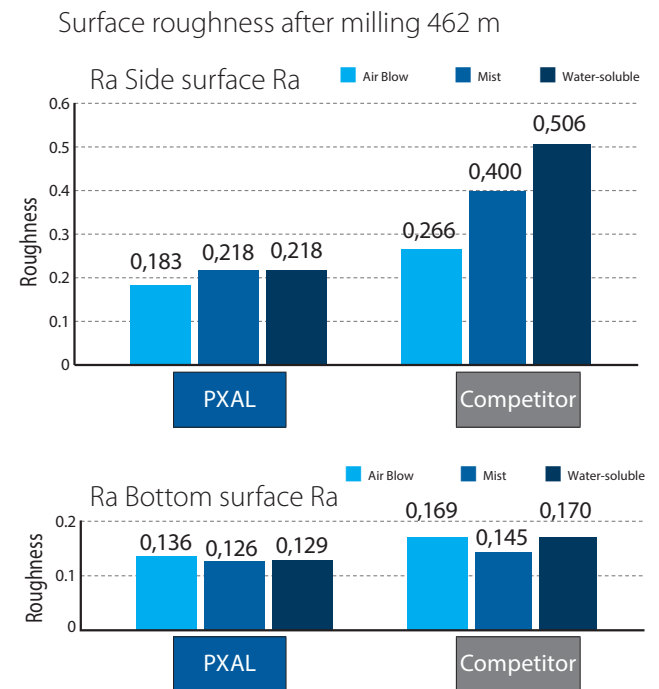

Milling | Indexables

Welding suppression by DLC coating

Tool	Head: PXAL160C16-03R010 Holder: PXMZ-C16SS16-S100	Non-coated Competitor
Size	Ø16 x R1	Ø16 x R1 3 flutes
Work Material	A7075	
Cutting Speed	600m/min (12.000min ⁻¹)	
Feed	2.700mm/min(0.075mm/t)	
Milling Method	Side Milling	
Depth of Cut	ap =8mm (0,5D) ae=4,8mm (0,3D)	
Overhang Length	50mm	
Coolant	None Air Blow	
Machine	Vertical Machining Center (BT40)	

Cutting edge condition after milling 300 m

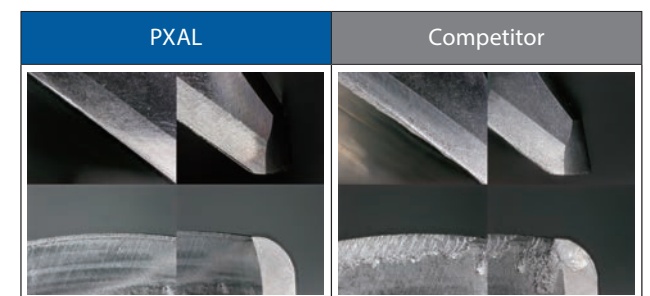

PXAL HEADS

Milling | Indexables



Type 1

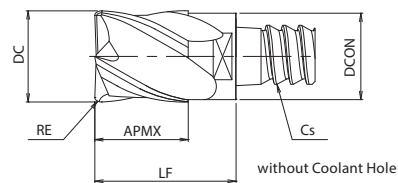

Type 2

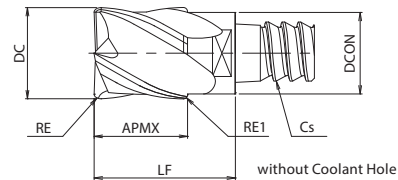

- Exchangeable Head End Mill
- Square, Corner Radius Type
- 3 flutes
- Non-ferrous materials, 10 -25 mm

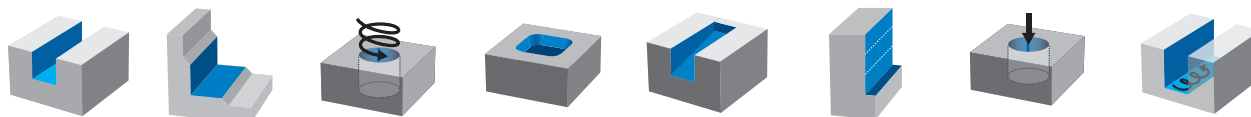

EDP	Designation	ZEFP	DC	RE	LF	FHA Helix Angle	APMX	DCON	Cs	Grade	Type	Price
7834930	PXAL100C10-03R000	3	10	0	16	45°	10	9,8	C10	XP4625	1	
7834931	PXAL100C10-03R100	3	10	1	16	45°	10	9,8	C10	XP4625	1	
7834932	PXAL100C10-03R250	3	10	2,5	16	45°	10	9,8	C10	XP4625	1	
7834933	PXAL120C10-03R000	3	12 ★	0	18	45°	12	9,8	C10	XP4625	2	
7834934	PXAL120C12-03R000	3	12	0	18	45°	12	11,7	C12	XP4625	1	
7834935	PXAL120C12-03R100	3	12	1	18	45°	12	11,7	C12	XP4625	1	
7834936	PXAL120C12-03R300	3	12	3	18	45°	12	11,7	C12	XP4625	1	
7834937	PXAL140C12-03R000	3	14 ★	0	20	45°	14	11,7	C12	XP4625	2	
7834938	PXAL160C16-03R000	3	16	0	23,5	45°	16	15,7	C16	XP4625	1	
7834939	PXAL160C16-03R100	3	16	1	23,5	45°	16	15,7	C16	XP4625	1	
7834940	PXAL160C16-03R200	3	16	2	23,5	45°	16	15,7	C16	XP4625	1	
7834941	PXAL160C16-03R300	3	16	3	23,5	45°	16	15,7	C16	XP4625	1	
7834942	PXAL160C16-03R400	3	16	4	23,5	45°	16	15,7	C16	XP4625	1	
7834943	PXAL180C16-03R000	3	18 ★	0	25,5	45°	18	15,7	C16	XP4625	2	
7834944	PXAL200C20-03R000	3	20	0	27,5	45°	20	19,6	C20	XP4625	1	
7834945	PXAL200C20-03R100	3	20	1	27,5	45°	20	19,6	C20	XP4625	1	
7834946	PXAL200C20-03R200	3	20	2	27,5	45°	20	19,6	C20	XP4625	1	
7834947	PXAL200C20-03R300	3	20	3	27,5	45°	20	19,6	C20	XP4625	1	
7834948	PXAL200C20-03R400	3	20	4	27,5	45°	20	19,6	C20	XP4625	1	
7834949	PXAL220C20-03R000	3	22 ★	0	29,5	45°	22	19,6	C20	XP4625	2	
7834950	PXAL250C25-03R000	3	25	0	35	45°	25	24	C25	XP4625	1	
7834951	PXAL250C25-03R100	3	25	1	35	45°	25	24	C25	XP4625	1	
7834952	PXAL250C25-03R300	3	25	3	35	45°	25	24	C25	XP4625	1	
7834953	PXAL250C25-03R500	3	25	5	35	45°	25	24	C25	XP4625	1	

★ PXAL
Reduced Shank Type

• The outer diameter of the reduced shank type is larger than the shank diameter, making it highly effective in the processing of die and mold applications that require vertical wall milling or pocketing.

Example

The R shape on the shank side edge prevents streaks during milling.

Milling | Indexables





- Straight Shank Holder for PXM
- Carbide Shank
- Shank & matching spanner sold as set

Type 1

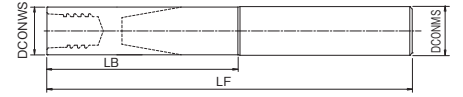

without Coolant Hole

Type 2

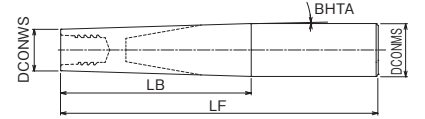

without Coolant Hole

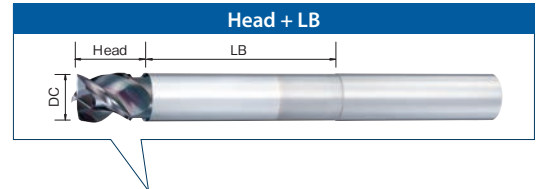

EDP	Designation	DCONWS	DCONMS	BHTA	LF	LB	Head + LB		CS	Type	Price
							PXAL DC				
							Ø10, 12, 16, 20, 25	Ø12, 14, 18, 22 Reduced Shank Type			
48174025	PXMZ-C10SS10-S075CS	9,8	10	0°	75	17,3	33,3	35,3	C10	1	
48174023	PXMZ-C10SS10-L100CS	9,8	10	0°	100	37,3	53,3	55,3	C10	1	
48174026	PXMZ-C10TP12-LL130CS	9,8	12	0,9°	130	67	83	85	C10	2	
48174008	PXMZ-C12SS12-S075CS	11,7	12	0°	75	24	42	44	C12	1	
48174009	PXMZ-C12SS12-L100CS	11,7	12	0°	100	45,9	63,9	65,9	C12	1	
48174010	PXMZ-C12SS12-L115CS	11,7	12	0°	115	64,2	82,2	84,2	C12	1	
48174011	PXMZ-C12TP16-LL135CS	11,7	16	1,3°	135	83,8	101,8	103,8	C12	2	
48174012	PXMZ-C16SS16-S090CS	15,7	16	0°	90	39,2	62,7	64,7	C16	1	
48174013	PXMZ-C16SS16-L130CS	15,7	16	0°	130	61,2	84,7	86,7	C16	1	
48174014	PXMZ-C16SS16-L135CS	15,7	16	0°	135	84,2	107,7	109,7	C16	1	
48174015	PXMZ-C16TP20-LL165CS	15,7	20	1,1°	165	115	138,5	140,5	C16	2	
48174016	PXMZ-C20SS20-S090CS	19,6	20	0°	90	39,1	66,6	68,6	C20	1	
48174017	PXMZ-C20SS20-L150CS	19,6	20	0°	150	78,4	105,9	107,9	C20	1	
48174018	PXMZ-C20SS20-L180CS	19,6	20	0°	180	109,1	136,6	138,6	C20	1	
48174019	PXMZ-C20TP25-LL200CS	19,6	25	1,1°	200	140	167,5	169,5	C20	2	
48174020	PXMZ-C25SS25-L200CS	24	25	0°	200	96,6	131,6	—	C25	1	

1. Adjust the position of the coolant nozzles accordingly so that the chips do not get tangled.
2. Also compatible with PXMZ shank holder with coolant hole.



Type 1



without Coolant Hole

Type 2

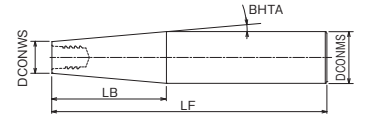

without Coolant Hole

- Straight Shank Holder for PXM
- Steel Shank
- Shank & matching spanner sold as set

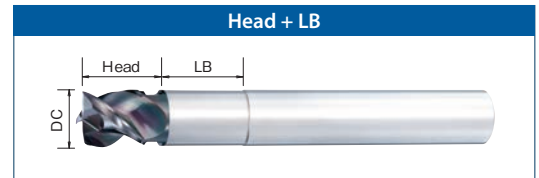

EDP	Designation	DCONWS	DCONMS	BHTA	LF	LB	Head + LB		CS	Type	Price
							PXAL DC				
							Ø10, 12, 16, 20, 25	Ø12, 14, 18, 22 Reduced Shank Type			
48174021	PXMZ-C10SS10-S075	9,8	10	0°	75	12	28	30	C10	1	
48174001	PXMZ-C12SS12-S100	11,7	12	0°	100	18	36	38	C12	1	
48174002	PXMZ-C12TP20-S145	11,7	20	5°	145	47.4	65.4	67.4	C12	2	
48174003	PXMZ-C16SS16-S100	15,7	16	0°	100	23	46.5	48.5	C16	1	
48174004	PXMZ-C16TP25-S155	15,7	25	5°	155	53.1	76.6	78.6	C16	2	
48174005	PXMZ-C20SS20-S120	19,6	20	0°	120	28	55.5	57.5	C20	1	
48174006	PXMZ-C20TP32-S170	19,6	32	5°	170	70.8	98.3	100.3	C20	2	
48174007	PXMZ-C25SS25-S140	24	25	0°	140	34.5	69.5	—	C25	1	

1. Adjust the position of the coolant nozzles accordingly so that the chips do not get tangled.
2. Also compatible with PXMZ shank holder with coolant hole.

Accessories

Tool	EDP	Designation	Applicable Head Dia.	Cs	Recommended Tightening Torque	Price
 Spanner	7801890	PXMP8-10	Ø10, Ø12	C10	10N•m	
	7801890	PXMP8-10	Ø12, Ø14	C12	12N•m	
	7801891	PXMP13-16	Ø16, Ø18	C16	30N•m	
	7801891	PXMP13-16	Ø20, Ø22	C20	50N•m	
	7801892	PXMP21	Ø25	C25	60N•m	

1. Please refer to p.21 for cautions during use.
2. Please refer to the table above for tightening torque.
3. Contact your nearest OSG sales representative for details of our dedicated adjustable torque wrench for tightening inserts.



CUTTING CONDITIONS

Milling | Indexables | Cutting conditions

PXAL

Side milling $L/D \leq 3$

Aluminum Alloy Expanding Material A5052 • A7075			
\emptyset	S (min^{-1})	F (mm/min)	
10	16.000	4.800	
12	13.300	3.990	
14	11.400	3.420	
16	10.000	3.600	
18	8.900	3.210	
20	8.000	3.840	
22	7.300	3.510	
25	6.400	3.840	
Depth of cut	ap		ae
	0,7 D		0,2 D

PXAL

Side milling $3 < L/D \leq 5$

Aluminum Alloy Expanding Material A5052 • A7075			
\emptyset	S (min^{-1})	F (mm/min)	
10	9.600	2.310	
12	8.000	1.920	
14	6.900	1.660	
16	6.000	1.730	
18	5.400	1.560	
20	4.800	1.850	
22	4.400	1.690	
25	3.900	1.880	
Depth of cut	ap		ae
	0,7 D		0,08 D

PXAL

Side milling $5 < L/D \leq 7$

Aluminum Alloy Expanding Material A5052 • A7075			
\emptyset	S (min^{-1})	F (mm/min)	
10	6.400	1.390	
12	5.400	1.170	
14	4.600	1.000	
16	4.000	1.040	
18	3.600	940	
20	3.200	1.110	
22	2.900	1.010	
25	2.600	1.130	
Depth of cut	ap		ae
	0,7 D		0,04 D

Milling | Indexables



CUTTING CONDITIONS

Milling | Indexables | Cutting conditions

PXAL

Slot milling L/D ≤ 3

 Aluminum Alloy Expanding Material A5052 • A7075					
Ø	S (min ⁻¹)	F (mm/min)			
10	16.000	4.800			
12	13.300	3.990			
14	11.400	3.420			
16	10.000	3.000			
18	8.900	2.670			
20	8.000	2.400			
22	7.300	2.190			
25	6.400	1.920			
Depth of cut	<table border="1"> <tr><td>ap</td></tr> <tr><td>0,5 D</td></tr> </table>			ap	0,5 D
ap					
0,5 D					

PXAL

Slot milling 3 < L/D ≤ 5

 Aluminum Alloy Expanding Material A5052 • A7075					
Ø	S (min ⁻¹)	F (mm/min)			
10	9.600	2.160			
12	8.000	1.800			
14	6.900	1.560			
16	6.000	1.350			
18	5.400	1.220			
20	4.800	1.080			
22	4.400	990			
25	3.900	880			
Depth of cut	<table border="1"> <tr><td>ap</td></tr> <tr><td>0,35 D</td></tr> </table>			ap	0,35 D
ap					
0,35 D					

PXAL

Slot milling 5 < L/D ≤ 7

 Aluminum Alloy Expanding Material A5052 • A7075					
Ø	S (min ⁻¹)	F (mm/min)			
10	6.400	960			
12	5.400	810			
14	4.600	690			
16	4.000	600			
18	3.600	540			
20	3.200	480			
22	2.900	440			
25	2.600	390			
Depth of cut	<table border="1"> <tr><td>ap</td></tr> <tr><td>0,2 D</td></tr> </table>			ap	0,2 D
ap					
0,2 D					

1. Use a rigid and precise machine and holder.
2. Please adjust the speed and feed when the depth of cut is large or when machines with low rigidity are used.
3. Please adjust the cutting condition when the overhang length is longer.
4. Please consider the overhang length as the total length of replaceable head and overhang length of shank holder.
5. When milling copper and copper alloys, lower the rotational speed by 20 to 40%, feed rate by 50 to 80%, and cutting depth by ap 50 to 80% in accordance with the table above.
6. Please always use the appropriate cutting fluid recommended by the cutting fluid manufacturer in the machining of magnesium alloys. Be cautious with the cutting chips as they are highly flammable and may pose a serious fire risk if not properly handled.

KEY FEATURES: PXMC COLLET

- 1 Powerful chip evacuation even on small machining center
- 2 The reduction of overhang length improves rigidity and rotational balance
- 3 A wide variety of exchangeable heads
 - Suitable for steel, stainless steel and aluminum
 - Wide processing range from roughing to finishing
- 4 Greater cost performance compared to monoblock type holders, only need to change the collet in case of trouble.

PXMC Collet Extra Short Type

Conventional Combination

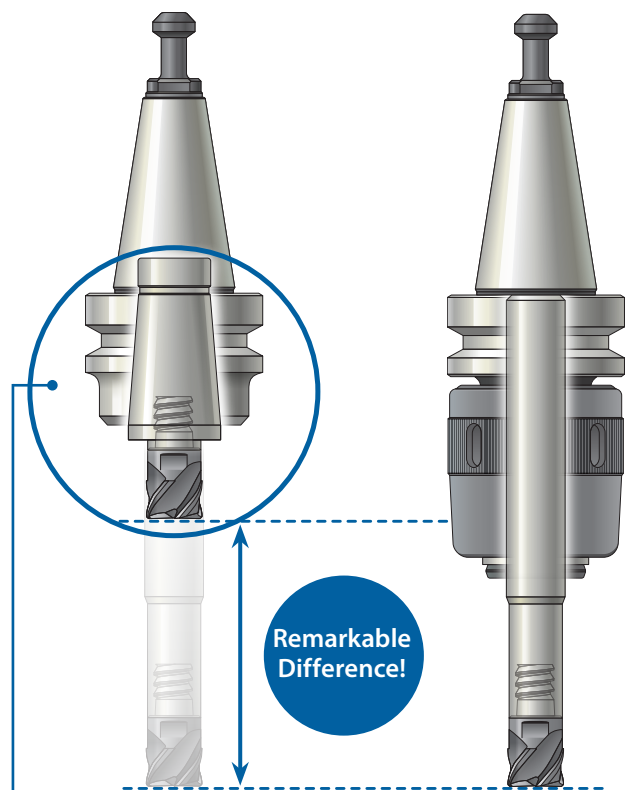

KEY FEATURES: PXM EXCHANGEABLE HEAD

Milling | Indexables

All the knowledge and know-how acquired by designing solid carbide end mills are found in these exchangeable heads.
 · Various types are available to meet variety of machining methods.

End Face + Taper = Double Face Clamping
 · High rigidity and accuracy of tightening
 · High precision of run out $\leq 0,015\text{mm}$
 · High head replacing accuracy = $\pm 0.03\text{mm}$

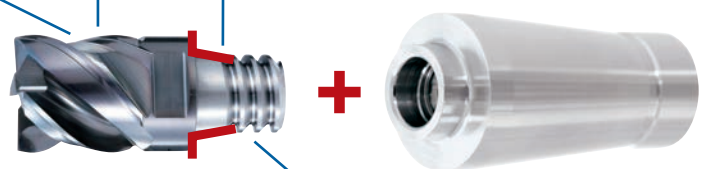

Applying buttress screw makes easy and reduces time to desorb heads

CUTTING CONDITIONS

Milling | Indexables | Cutting conditions

PXAL + PXMC

Side milling Extra Short Type

 Aluminum Alloy Expanding Material A5052 • A7075			
Ø	S (min ⁻¹)	F (mm/min)	
12	10.000	3.000	
14	10.000	3.000	
16	10.000	3.000	
18	8.900	3.210	
20	8.000	2.880	
22	7.300	3.510	
25	6.400	3.080	
Depth of cut	ap		ae
	0,7 D		0,2 D

PXAL + PXMC

Slot milling Extra Short Type

 Aluminum Alloy Expanding Material A5052 • A7075			
Ø	S (min ⁻¹)	F (mm/min)	
12	10.000	3.000	
14	10.000	3.000	
16	10.000	3.000	
18	8.900	2.670	
20	8.000	2.400	
22	7.300	2.190	
25	6.400	1.920	
Depth of cut	ap		
	0,5 D		

1. Please adjust speed and feed when the depth of cut is large or machines with low rigidity are used.
2. When milling copper and copper alloys, lower the rotational speed by 20 to 40%, feed rate by 50 to 80%, and cutting depth by ap 50 to 80% in accordance with the table above.
3. Please always use the appropriate cutting fluid recommended by the cutting fluid manufacturer in the machining of magnesium alloys. Be cautious with the cutting chips as they are highly flammable and may pose a serious fire risk if not properly handled.



CUTTING CONDITIONS

Milling | Indexables | Cutting conditions

PXAL + PXMC

Side milling Short Type

 Aluminum Alloy Expanding Material A5052 • A7075			
Ø	S (min ⁻¹)	F (mm/min)	
12	10.000	2.700	
14	10.000	2.700	
16	10.000	2.700	
18	8.900	2.890	
20	8.000	2.600	
22	7.300	3.160	
25	6.400	2.770	
Depth of cut	ap		ae
	0,7 D		0,2 D

PXAL + PXMC

Slot milling Short Type

 Aluminum Alloy Expanding Material A5052 • A7075			
Ø	S (min ⁻¹)	F (mm/min)	
12	10.000	2.700	
14	10.000	2.700	
16	10.000	2.700	
18	8.900	2.410	
20	8.000	2.160	
22	7.300	1.980	
25	6.400	1.730	
Depth of cut	ap		
	0,5 D		
1. Please adjust speed and feed when the depth of cut is large or machines with low rigidity are used. 2. When milling copper and copper alloys, lower the rotational speed by 20 to 40%, feed rate by 50 to 80%, and cutting depth by ap 50 to 80% in accordance with the table above. 3. Please always use the appropriate cutting fluid recommended by the cutting fluid manufacturer in the machining of magnesium alloys. Be cautious with the cutting chips as they are highly flammable and may pose a serious fire risk if not properly handled.			



MOUNTING PROCEDURE



1. Initial Tightening (BT30)

Make sure the fastening portion of the collet is clean then insert it into the holder. Turn the pull stud to tighten.

*For models other than BT30 please refer to the instructions below.



2. Final Tightening

Tighten with a spanner wrench



3. Cleaning

Remove dirt and chips from the connecting thread and collet



4. Mounting the Head

After screwing the head in by hand, use the PXM spanner wrench to tighten.

Mounting procedure for holders other than BT30

①

Insert the hexagon socket wrench into the pull screw hexagonal section.
*For pull studs with holes ($\phi 6$ or above), it is operational with the stud being attached.

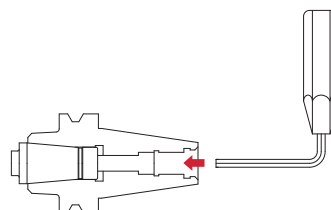

②

To prevent the collet from rotating, support the tip of the collet by hand, tighten with the wrench by turning to the right, then fastening to the required torque.
*Recommended tightening torque: 18N·m

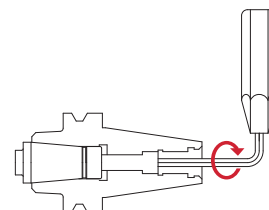

Cautions during use

- Only use the spanner wrenches that are designed specifically for the PXM (p.24) for attaching PXM heads.
- Please do not use alternative spanner wrenches sold on the market as a replacement.
- Please refer to p.24 for tightening torque.
- Please tighten until the head and the collet faces meet. Confirm that there is no gap.
- Degreasing the connecting thread may result in over tightening or a possible separation of the faces. Please do not degrease.
- Please make sure that the spanner wrench is inserted properly and turn it slowly during use.

Abundant exchangeable milling heads! Exchangeable head end mill PXM

The PXM is an exchangeable head end mill series with the same high performance of a solid tool and the cost efficiency of an indexable tool. A single exchangeable head body is able to accommodate a wide range of exchangeable heads to meet various application needs.

Available shapes

- Square Type
- Roughing Type
- Corner Radius Type
- Ball Type

Please see OSG PHOENIX Catalog for details.





shaping your dreams

OSG EUROPE LOGISTICS

Avenue Lavoisier 1
B-1300 Z.I. Wavre - Nord - Belgium
Tel: +32 10 23 05 07
Fax: +32 10 23 05 51
info@osgeurope.com

OSG POLAND Sp. z.o.o.

Spółdzielcza 57
05-074 Halinów - Poland
Tel: +22 760 82 71
Fax: +22 760 82 71
osg@osg-poland.com

OSG TURKEY

Rami Kişla Cad.No:56 Eyüp
Istanbul 34056 - Turkey
Tel:+90 212 565 24 00
Fax: +90 212 565 44 00
info@osg-turkey.com

OSG BELUX

Avenue Lavoisier 1
B-1300 Z.I. Wavre - Nord - Belgium
Tel: +32 10 23 05 11
Fax: +32 10 23 05 31
info@osg-belgium.com

OSG GERMANY

Karl-Ehmann-Str. 25
D - 73037 Göppingen - Germany
Tel: +49 7161 6064 - 0
Fax: +49 7161 6064 - 444
info@osg-germany.de

ROMSAN INTERNATIONAL CO. SRL

Reprezentant Exclusiv OSG
25C, Bucuresti-Magurele Street
051431 Bucuresti - România
Tel: +40 21 322 07 47
Fax: +40 21 321 56 00
romsan.int@romsan.ro

OSG FRANCE

Parc Icade, Paris Nord 2
Immeuble "Le Rimbaud"
22 Avenue des Nations
CS66191 - 93420 Villepinte - France
Tel: +33 1 49 90 10 10
Fax: +33 1 49 90 10 15
sales@osg-france.com

OSG SCANDINAVIA

(For Scandinavian countries)
Langebjergvaenget 16
4000 Roskilde - Denmark
Tel: +45 46 75 65 55
Fax: +45 46 75 67 00
osg@osg-scandinavia.com

AUSTRIA

Branch office of OSG GERMANY
Messestraße 11
A-6850 Dornbirn
Tel: +49 7161 6064-0
Fax: +49 7161 6064-444
info@osg-germany.de

OSG NETHERLANDS

Bedrijfsweg 5 - 3481 MG Harmelen
Tel: +31 348 44 2764
Fax: +31 348 44 2144
info@osg-nl.com

SWEDEN

Branch office of OSG SCANDINAVIA
Abrahams Gränd 8
295 35 Bromölla - Sweden
Tel: +46 40 41 22 55
Fax: +46 40 41 32 55
osg@osg-scandinavia.com

OSG ITALIA

Via Ferrero, 65 A/B
I - 10098 Rivoli - Italy
Tel: +39 0117705211
Fax: +39 0117705215
info@osg-italia.it

OSG UK

Shelton house, 5 Bentalls
Pipps Hill Ind Est, Basildon Essex SS14 3BY
Tel: +44 1268 567 660
Fax: +44 1268 567 661
uk_sales@osg-uk.com

OSG IBERICA

Bekolarra 4
E - 01010 Vitoria-Gasteiz - Spain
Tel: +34 945 242 400
Fax: +34 945 228 883
osg.iberica@osg-ib.com

Vischer & Bolli AG

Machining and Workholding
Im Schossacher 17
CH-8600 Dübendorf
T +41 44 802 15 15
F +41 44 802 15 95
info@vb-tools.com

CZECH, SLOVAKIA, HUNGARY

OSG Europe Logistics S.A.
Slovakia organizacna zlozka
Racianská 22/A, SK-83102 Bratislava
Slovakia
Tel. +421 24 32 91 295
Orders-osgsvk@osgeurope.com

RUSSIA

Butlerova street, 17B, office 5069
117342 Moscow - Russia
Tel: +7 (495) 150 41 54
info@osg-russia.com

OSG EUROPE LOGISTICS S.A.

01/2022 - All rights reserved. © OSG Europe 2022.

The contents of this catalogue are provided to you for viewing only. They are not intended for reproduction either in part or in whole in this or other medium. They cannot be copied, used to create derivation work or used for any reason, by means without the express, written permission of the copyright owner. If prices are stated, they are netto unit-prices and any eventual tax(es) have to be added. The company is not responsible for any printing error in technical, price and/or any other data.

Tool specifications subject to change without notice.

www.osgeurope.com